



Roof Truss Tables

Copyright © 2018, 2020 MiTek®. All rights reserved.

001090 rev. C

Patented. See Legal Notice for list of patents.

Manual applies to United States equipment.

CAUTION

MiTek recommends printing this manual in high resolution using color ink. Many of the graphics may be unclear and may create an unsafe condition if this recommendation is not followed.

Roof Truss Tables

MiTek Machinery Division
301 Fountain Lakes Industrial Drive
St. Charles, MO 63301
Phone: 800-523-3380
Fax: 636-328-9218
www.mitek-us.com

Part # and Rev.	001090 rev. C
Print Date	13 July 2022
Effectivity	31580-xxx 31595-xxx 31610-xxx
Revision Date	21 May 2021
Revised By	A. McIntire
Orig. Release Date	1 April 2007
Created By	R. Widder

Legal Notice

Patents

Made and sold under one or more of the following patents:

U.S. 4,986,052	U.S. 5,837,014	U.S. 6,219,975
U.S. 5,385,339	U.S. 5,854,747	U.S. 6,260,263
U.S. 5,493,834	U.S. 5,873,567	U.S. 6,317,980
U.S. 5,568,862,	U.S. 5,884,448	U.S. 6,389,762
U.S. 5,630,697	U.S. 5,885,731	U.S. 6,401,422
U.S. 5,636,494	U.S. 5,906,264	U.S. 6,412,246
U.S. 5,638,658	U.S. 5,934,866	U.S. 6,418,601
U.S. 5,640,832	U.S. 5,947,460	U.S. 6,539,615
U.S. 5,655,399	U.S. 5,987,828	U.S. 6,666,367
U.S. 5,678,395	U.S. 5,996,303	U.S. 6,702,269
U.S. 5,702,095	U.S. 6,048,165	U.S. 6,758,022
U.S. 5,707,204	U.S. 6,112,968	U.S. 6,817,392
U.S. 5,735,087	U.S. 6,134,775	U.S. 6,834,470
U.S. 5,810,341	U.S. 6,170,688	U.S. 6,907,820
U.S. 5,819,412	U.S. 6,205,637	Other patents may apply
U.S. 5,833,222	U.S. 6,212,849	

Return Goods Policy

Return goods cannot be accepted without prior authorization and are subject to a restocking charge. The Seller certifies the articles specified herein were produced in compliance with all provisions of the Fair Labor Standards Act of 1938, as amended, including Section 12.—Rev. 6/98.

Corrections and Improvements

To report errors or recommend improvements to this manual, please complete the Document Evaluation Form in the appendices. Mail or fax the form to:

MiTek Machinery Division
301 Fountain Lakes Industrial Drive
St. Charles, MO 63301
Attn: Engineering Manager, Fax: 636-328-9218

Table of Contents

Legal Notice	ii
Patents	ii
Return Goods Policy	ii
Corrections and Improvements	ii
Notice of Change	iii
Safety (English)	vii
Safety Indicator Signal Words	vii
Safety Requirements	viii
General Equipment Safety Rules	viii
Lockout/Tagout	xi
Troubleshooting with an Energized Machine	xiv
Safety Tests	xv
Restricted Zone	xvi
Safety Symbol Definitions	xvii
Declaration of Safety Conformity	xxi
Seguridad (Español)	xxii
Indicadores de seguridad: Palabras de aviso	xxii
Requerimientos de seguridad	xxiii
Reglas general de seguridad para el equipo	xxiii
Bloqueo/Etiquetado	xxvii
Solución de problemas con una máquina energizada	xxx
Prueba de seguridad	xxxi
Zona Restringida	xxxii
Información adicional	xxxii
Introduction	1
Introduction to the Manual	1
Purpose of This Manual	1
Scope of This Manual	2
The Drawing Set	2
Additional Resources	4
Website	4
Phone or E-mail Support	4
Contact Information	4
General Information	5
Introduction to the Equipment	5
Purpose of the Equipment	5
Description of the Equipment	5
Safety Compliance of the Equipment	5
Components Overview	7
Technical Specifications	7
Installation	8
Installation Requirements	8
Environmental Requirements	8
Infrastructure Requirements	8

Table of Contents

Responsibilities During Installation	10
Responsibilities Before Moving or Selling	10
Marking Restricted Zone	10
Marking Area on Your Own	10
Installing MiTek Restricted Zone Tape	10
Local Codes and Regulations	11
Operation	12
Before You Begin	12
Operator Controls	13
Stopping the Machine	13
Understanding the Table Components	13
Control Valves	13
Operating Procedure	15
Operating the Tables	15
Operating the Pneumatic Ejection System	15
Maintenance	17
Performing Maintenance Safely	17
Before Operating This Machine	17
Lockout/Tagout	18
Important Safety Information	18
Making Adjustments and Replacing Parts	20
Wearing Personal Protective Equipment	21
Testing the Safety of the Machine	21
Cleaning and Inspecting	21
Cleaning	21
Inspecting the Ejectors	22
Inspecting the Ejection System as a Whole	22
Pneumatic System Maintenance	22
Removing Pressure from the Pneumatic System	22
Filter/Regulator	23
Setup Valve	24
Control Valves	25
Ejector Cylinders	26
High Slope Ejector Bumpers	27
Troubleshooting	29
Safety Notes for Troubleshooting	29
General Troubleshooting Safety Tips	29
Electrical Troubleshooting Safety Tips	30
Getting Started with Troubleshooting	31
Tools Required	31
First Steps	32
Problems and Solutions	33
Parts List	34
Ordering Parts	34
Stocking Spare Parts	34
Safety Notes for Replacement Parts	34
List of Parts to Keep in Stock	35
Maintenance Checklist	36
Using the Maintenance Checklists	36
Safety Notes for the Maintenance Checklists	36
Checklist	37

Table of Contents

Drawing Set	38
Document Evaluation	39
Document Evaluation Form	40
General Evaluation	40
Specific Evaluation	40
Glossary	41
Index	45

Safety (English)

**Purpose
of Chapter**

This chapter explains general information and specific procedures for operating the machine safety.

Safety Indicator Signal Words

The following signal words and colors are used throughout this document to indicate safety hazards. Pay careful attention when you see them. The level of severity differs for each signal word and color.

Signal words are accompanied by graphics showing what personnel should or should not do. The graphics are called safety symbols and are defined on page xvii, but more specific text is provided every time a graphic is used throughout the manual. Everyone near the machine must be trained on how to read these safety indicators.

Failure to comply with the instructions accompanying each signal word may result in property damage, personal injury, or even death. Personnel must follow all safety procedures and practices to ensure the safest possible operation of this equipment. However, at no time is this document a substitute for common sense. Personnel must ensure that the work environment is safe and free of distractions.



Refiérase a la página xxii para español.

For safety information in Spanish, refer to page xxii

danger Indicates an imminently hazardous situation which, if not avoided, is likely to result in death or serious injury.
warning Indicates a potentially hazardous situation, which, if not avoided, may result in death or serious injury.
caution Indicates a potentially hazardous situation which, if not avoided, may result in minor or moderate injury.
notice Calls attention to information that is significant to understanding the operation at hand or the potential for property damage.
environmental Applies to conditions that may affect the environment but do not have an immediate, direct effect on personnel or equipment.

Safety Requirements

Because it is impossible to anticipate every circumstance that might involve a hazard, the safety information provided in this equipment manual and on the machine is not all-inclusive. If this machine is operated or serviced using a procedure not specifically recommended by the manufacturer, the procedure shall be approved by a professional engineer to ensure it will not render the equipment unsafe. Use extreme caution and common sense at all times.

General Equipment Safety Rules

Know Your Equipment

- Read this manual completely before using or maintaining the equipment. Do not operate this machine unless you have a thorough knowledge of the controls, safety devices, emergency stops, and operating procedures outlined in this manual.
- Read and follow all safety notes. Failure to comply with these instructions may result in economic loss, property damage, and/or personal injury including death.
- Refer to the lockout/tagout guidelines on the following pages to safely perform maintenance and troubleshooting of this equipment.
- Observe and obey all safety labels. Replace worn labels immediately.
- Use this equipment solely for the purpose described in this manual.
- *MiTek* equipment is designed to work with optional accessories and other *MiTek* machines. When applicable, refer to the appropriate equipment manual for specific safety information.
- Only qualified personnel should attempt to operate or perform maintenance on this equipment. “Qualified personnel” is defined as:

...a person or persons who, by possession of a recognized degree or certificate of professional training, or who, by extensive knowledge, training, or experience, has successfully demonstrated the ability to solve problems relating to the subject matter and work—ANSI B30.2-1983

...one who has skills and knowledge related to the construction and operation of the electrical equipment and installations and has received safety training on the hazards involved—NEC 2002 Handbook

Personal Safety

- Always wear safety glasses and hearing protection in an industrial environment.
- Utilize a filtering face piece (dust mask) when working near sawdust.
- Wear proper clothing and appropriate personal protective equipment (e.g., safety glasses and hearing protection.) Do not wear loose clothing or jewelry. Confine long hair by tying it back.
- Use caution when lifting heavy parts or material.
- Pay attention to your surroundings.

Safety

Installing the Equipment

- Follow installation instructions completely.
- This equipment is not for use in a residential area.

Lockout/Tagout

- Before performing maintenance on the pneumatic or hydraulic systems, bleed the lines to eliminate pressure. Refer to *Removing Pressure from the Pneumatic System*.
- Lockout/tagout all energized systems before performing maintenance on them. Refer to lockout/tagout guidelines in on page xi.



Keeping a Safe Environment

- Keep children away. All visitors should be kept a safe distance from the work area. Hazards may not be apparent to individuals unfamiliar with the machine.
- Keep work areas well lit.
- Keep the work area clean and free of any trip or slip hazards.
- Do not use the equipment in damp or wet locations, or expose it to rain or snow.
- Minimize dust clouds and protect your equipment by cleaning dust in this manner:
 - a) Vacuum dust prior to blowing with air
 - b) Shut down electrical power and sources of ignition
 - c) If using compressed air, it should be a low compression (no more than 15 psi)
 - d) Powered cleaning equipment such as vacuums must be consistent with local governmental codes for use in dusty conditions.

Operating and Maintaining the Equipment

- Ensure that all people, tools, and foreign objects are clear of the restricted zones before operating this equipment. The restricted zones are shown on page xvi.
- Perform safety tests to ensure all E-stops are working properly before operating the equipment at the initial startup, after performing any maintenance, and in accordance with the maintenance schedule.
- In case of machine malfunction, stop the machine immediately using an E-stop and report the malfunction to a supervisor.
- Never leave the machine running unattended. Turn the power off! Do not leave the machine until all parts have come to a complete stop and all electrical power has been shut off.
- Check for worn or damaged parts regularly. Repair or replace them immediately.
- Keep the hydraulic, pneumatic, and electrical systems in good working order at all times. Repair leaks and loose connections immediately. Never exceed the recommended pressure or electrical power.

Safety

- Check that all safety devices are in working order before each shift starts. All protective guards and safety devices must be in place before and during use of the machine. Never disconnect or bypass any safety device or electrical interlock.
- Only qualified maintenance personnel shall remove or install safety devices.
- Periodically inspect the quality of the finished product.

Electrical Safety

- Do not use any liquids in the interior of electrical cabinets.
- When using solvents on and around the machine, remove power to the machine to eliminate the chance of sparking, resulting in explosion or fire. Wear a respirator approved for use with solvents. Wear protective clothing, gloves, and safety glasses.

Safety

Lockout/Tagout

Lockout/Tagout Guidelines

All lockout/tagout guidelines must be met according to OSHA 29 CFR 1910.147. A specific procedure should be included in your company's energy control program. This manual is not intended to replace your company's de-energizing or lockout/tagout procedure required by OSHA, but merely to provide general guidance.

The term "lockout," as used in this manual, means placing a lockout device on any and all energy sources to ensure that the energy isolating device and the equipment being controlled cannot be re-energized or operated until the lockout device is removed. Figure 1-2 shows where the electrical disconnects are located for this machine.

- Energy sources include electrical, mechanical, hydraulic, pneumatic, chemical, thermal, or other energy.
- In the case of electrical energy sources, the main power and control power to the machinery must be turned off and physically locked in the Off position.
- A lockout device is usually a keyed padlock.

If more than one person is working in a restricted zone, use a group lockout device that will allow each person to use a lock that can be removed only by the person performing the maintenance.

"Tagout" means that a prominent warning is securely fastened to an energy-isolating device to indicate that the equipment shall not be operated.

Whenever you see this symbol, lockout/tagout!

Figure 1-1: An Example of a Lockout/Tagout Device



Safety

Electrical Lockout/Tagout Procedures: Outside Machine's Enclosure





If you are working inside the machine's enclosure, follow the procedure on page xiii.



Before performing maintenance on any machine with electrical power, lockout/tagout the machine properly. When working on a machine outside of the machine's main electrical enclosure, not including work on the electrical transmission line to the machine, follow your company's approved lockout/tagout procedures which should include, but are not limited to the steps here.

1. Engage an E-stop on the machine.
2. Turn the disconnect switch handle to the Off position. See Figure 1-2.

 WARNING	
	<p>ELECTROCUTION HAZARD.</p> <p>When the disconnect switch is off, there is still live power within the disconnect switch's enclosure. Always turn off the power at the building's power source to the equipment before opening this electrical enclosure.</p>

3. Attach a lock and tag that meet OSHA requirements for lockout/tagout.
4. Restrain or de-energize all pneumatic components, hydraulic components, and other parts that could have live or stored power.

Figure 1-2: Disconnect Switches to Lockout /Tagout for Various Maintenance

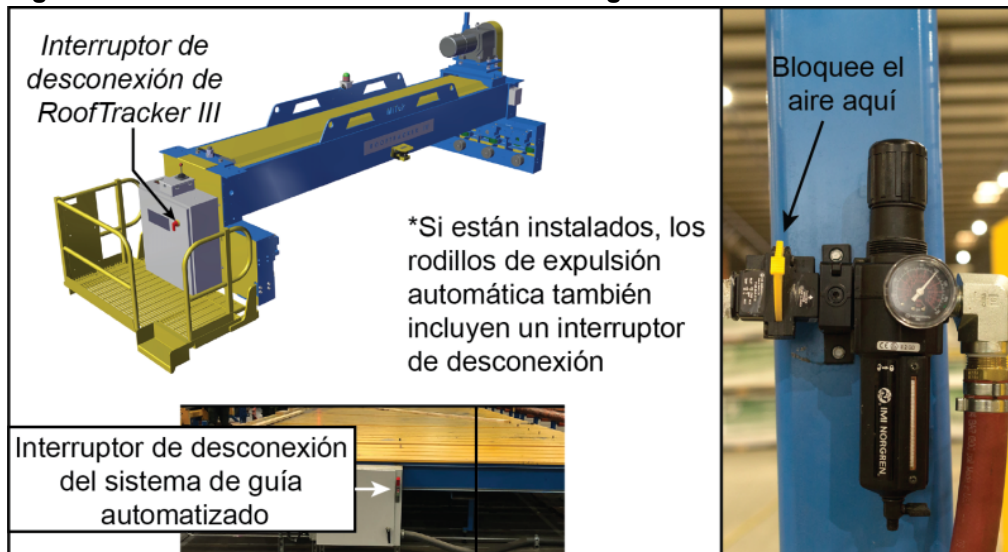

Safety

Electrical Lockout/Tagout Procedures:

Inside Machine's Enclosure



If you are working on the electrical transmission line to the machine, follow the procedure on page xii.



Before opening the main electrical enclosure, or attempting to repair or replace an electrical transmission line to the machine, lockout/tagout the machine properly. Follow your company's approved lockout/tagout procedures which should include, but are not limited to the steps here.

1. Engage an E-stop on the machine.
2. Shut the power to the machine off at the machine's power source which is usually an electrical service entry panel on the facility wall. One example of a locked-out power source panel is shown in Figure 1-3.
3. Attach a lock and tag that meets OSHA requirements for lockout/tagout.
4. Open the door to the enclosure in which you need access, and using a multimeter, verify that the power is off.

Figure 1-3: Sample of a Lockout/Tagout Mechanism on a Power Source Panel



Safety

Pneumatic System Lockout/Tagout Procedure: WITH Lockout/Tagout

If working on components other than the pneumatic system, but that requires you to be near the vicinity of movable pneumatic components, you must, at a minimum, physically restrain the pneumatic components from moving. If this is not possible, lockout/tagout the entire pneumatic system.



Pneumatic System Lockout/Tagout Procedure: WITHOUT Lockout/Tagout

Before attempting repair or maintenance on a pneumatic line or component, lockout/tagout the machine properly. Follow your company's approved lockout/tagout procedures.

Troubleshooting with an Energized Machine

Only a qualified electrician, using the personal protective equipment and following the procedures recommended in NFPA 70E should ever attempt service or repair of or near an energized area or component of the machine.

Whenever maintenance is performed while the equipment is electrically energized, there is a potential electric arc flash hazard. Refer to NFPA 70E for the personal protective equipment required when working with electrically energized components. Pneumatic and hydraulic components may move unexpectedly if not de-energized. Physically restrain any components capable of movement when working on or near those components.

Safety Tests

This test procedure **MUST** be performed by qualified personnel at startup and after ANY maintenance, adjustment, or modification.

1. Ensure air pressure is set to 100 PSI. See *Adjusting the Pressure*.
2. Actuate each setup to test that the ejectors raise when expected and lower when expected at a reasonable speed.

Restricted Zone



	 DANGER
	<p>Stay out of the restricted zone when equipment is in use. Serious injury or death may result if personnel are in the restricted zone.</p> <p>Always look for personnel in the restricted zone before operating equipment.</p>

Figure 1-4: Know the Restricted Zone







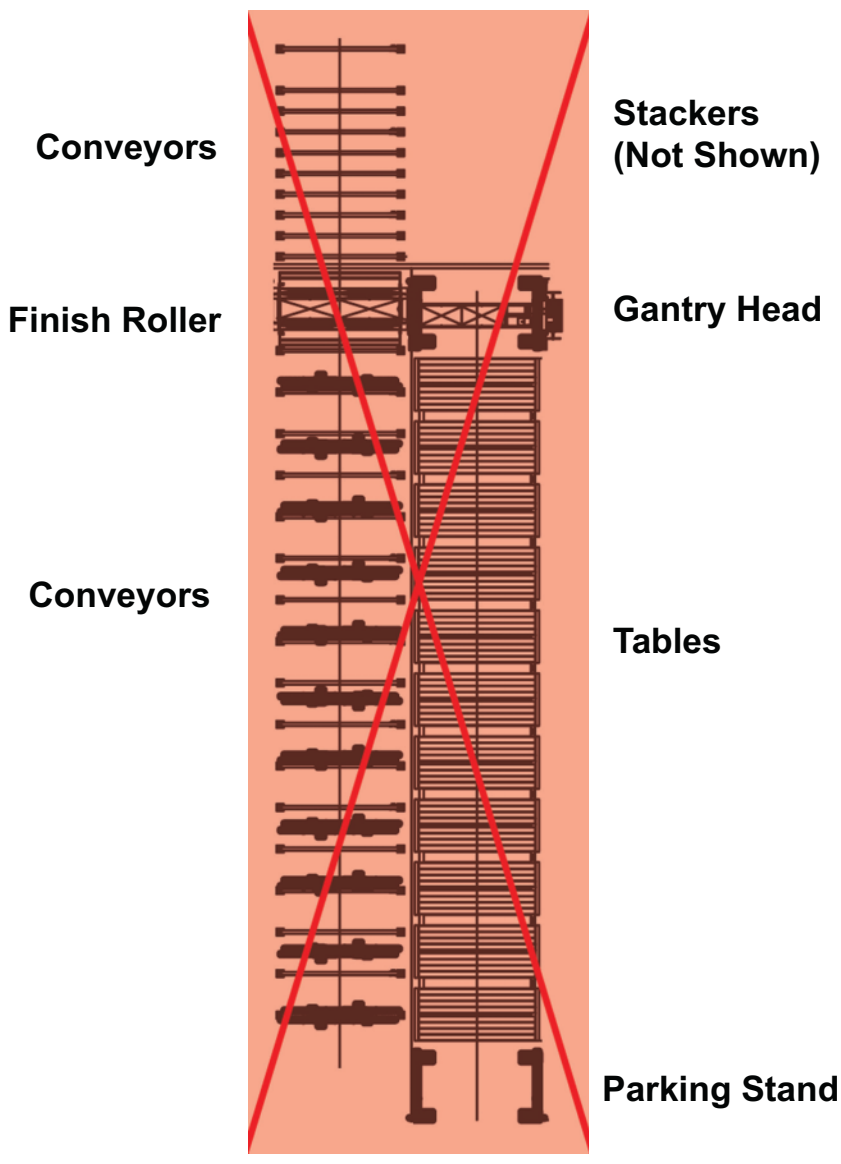

Marking the Restricted Zone







The restricted zone must be marked so everyone near the equipment can clearly see the area where danger may exist. See page 10 for more details.

Safety Symbol Definitions



The safety symbols shown in this section are found throughout the manual to indicate hazards related to this machine. All personnel expected to operate or maintain this machine should be familiar with these safety symbols and their meanings.

	<p>User caution. It indicates a condition where equipment damage resulting in injury could occur if operational procedures are not followed. To reduce risk of damage or injury, refer to accompanying documents, and follow all steps or procedures as instructed.</p>
	<p>Electrical hazard. It indicates dangerous high voltages inside of an enclosure and/or the presence of a power source. To reduce the risk of fire or electric shock, do not attempt to open the enclosure or gain access to areas where you are not instructed to do so. Refer servicing to qualified service personnel only.</p> <p>This equipment should be operated only from the type of source indicated on the manufacturer's identification label. Installation should be in compliance with applicable sections of the national electric code. Consult your local building code before installing.</p>
 	<p>Crush hazard. Keep hands clear.</p>
	<p>Trip hazard. Pay attention when walking in this area.</p>
 	<p>Keep hands and body clear.</p>









Safety

	Keep hands away from moving parts.
	High pressure hose. Use appropriate PPE when working on equipment. Maintain safe pressure level at all times.
	Use sling equipment rated for at least ___ lbs / ___ kgs when lifting this equipment.
	Do not use unapproved lubricants in this equipment.
	Do not operate without guards in place.
	Indicates notes regarding lubrication.

Safety

	<p>The operation of this equipment requires the use of PPE. Do not operate without wearing the required protective clothing.</p> 
	<p>Refer to manual. After installation, read the user's guide carefully before operating. Follow all operating and other instructions carefully.</p>

Safety

	<p>Circuits are live. Lockout/tagout on the upstream disconnect prior to servicing.</p>
	<p>Lockout in a de-energized state.</p>
  	<p>Lift point. In order to decrease the likelihood of damage to the equipment, use only the lift points indicated in the manual.</p>
	<p>To reduce the risk of equipment damage or injury to personnel, maintain pressure at safe levels.</p>
	<p>Read all safety warnings and instructions before proceeding.</p>
	<p>No lift point. Do not lift this device with a hook/crane assembly. Equipment damage occurs. Refer to the installation instructions.</p>

Declaration of Safety Conformity

Conforms electrically to the following:

- NFPA 79
- NEC Electrical Code
- Electrical enclosures carry UL 508A and the CUL for Canada
- Safety circuit conforms to Category 4 redundant monitoring

Conforms mechanically to the following:

- 10CFR 1910
- ANSI B 11.19

Seguridad (Español)

**Objetivo
del Capítulo**

Este capítulo explica la información general y los procedimientos específicos para operar la máquina de manera segura.

Indicadores de seguridad: Palabras de aviso

Las siguientes palabras y colores de aviso se utilizan a lo largo de este documento para indicar riesgos de seguridad. Preste suma atención cuando los vea. El nivel de gravedad es diferente por cada palabra o color de aviso.

Las palabras de aviso van acompañadas por gráficos que muestran al personal lo que deben y no deben hacer. Los gráficos se llaman símbolos de seguridad y se definen en la página xvii pero se proporciona un texto más específico cada vez que se utiliza un gráfico por todo el manual. Todas las personas que estén cerca de una máquina tienen que ser capacitadas en cómo leer estos indicadores de seguridad.

No cumplir las instrucciones que acompañan cada palabra de aviso puede producir daños a la propiedad, lesiones personales e incluso la muerte. El personal debe seguir todos los procedimientos y prácticas de seguridad establecidos para asegurar el uso más seguro posible de este equipo. No obstante, en ningún caso este documento reemplaza el sentido común. El personal debe asegurarse de que el entorno de trabajo sea seguro y esté libre de distracciones.

Peligro Indica una situación de peligro inminente que, si no se evita, ocasionará la muerte o graves lesiones.
Advertencia Indica una situación potencialmente peligrosa que, si no se evita, podría producir la muerte o lesiones graves.
Precaución Indica una situación potencialmente peligrosa que, si no se evita, puede producir lesiones menores o moderadas.
Aviso Llama la atención a información importante para entender la operación que se desea realizar o daños a la propiedad probables.
Ambiental Se aplica a condiciones que pueden afectar el entorno pero que no tienen un efecto inmediato o directo sobre el personal o el equipo.

Requerimientos de seguridad



Debido a la imposibilidad de anticipar todas las circunstancias que podrían constituir un riesgo, la información de seguridad suministrada en este manual del equipo y sobre la máquina no es exhaustiva. Si se utiliza o realiza el mantenimiento de esta máquina utilizando un procedimiento no recomendado específicamente por el fabricante, el procedimiento deberá ser aprobado por un ingeniero profesional para asegurarse de que no afecte la seguridad del equipo. ¡Manéjese siempre con suma precaución y sentido común!

Reglas general de seguridad para el equipo

Conozca su equipo

- Lea este manual en su totalidad antes de utilizar o mantener el equipo. No utilice esta máquina a menos que esté perfectamente familiarizado con los controles, los dispositivos de seguridad, los frenos de emergencia y los procedimientos operativos que se describen en este manual.
- Lea y siga todas las notas de seguridad. El no cumplimiento de estas instrucciones podría producir pérdidas económicas, daños a la propiedad y/o lesiones personales, incluida la muerte.
- Refiérase a las pautas de bloqueo/etiquetado proporcionadas en las siguientes páginas para realizar el mantenimiento y solucionar problemas de este equipo en forma segura.
- Observe y cumpla con todas las etiquetas de seguridad. Cambie las etiquetas gastadas inmediatamente.
- Utilice este equipo únicamente para el propósito que se describe en este manual.
- El equipo MiTek está diseñado para funcionar con accesorios opcionales y otras máquinas MiTek. Cuando sea necesario, consulte el manual del equipo correspondiente para obtener información de seguridad específica.
- Sólo personal calificado debe intentar utilizar o realizar el mantenimiento de este equipo. Por "personal calificado" se entiende:

...una persona o personas que, por el hecho de poseer un título o certificado de capacitación profesional reconocido o que, por sus amplios conocimientos o experiencia, han demostrado con éxito estar capacitados para resolver problemas relacionados con el tema y el trabajo en cuestión—ANSI B30.2-1983

...una persona que posee habilidades y conocimientos relacionados con la construcción y uso de equipos e instalaciones eléctricas y que ha recibido capacitación en seguridad sobre los riesgos posibles—NEC 2002 Handbook

Seguridad personal

- Use siempre lentes de seguridad y protección auditiva en un entorno industrial.
- Utilice una máscara protectora cuando trabaje cerca de aserrín.

Seguridad

- Utilice ropa adecuada y equipo de protección personal apropiado (por ejemplo, lentes de seguridad y protección auditiva.) No use ropa suelta ni joyas. Si tiene el cabello largo, áteselo para atrás.
- Proceda con precaución cuando levante piezas o materiales pesados.

Seguridad

Instalació del equipo

- Siga las instrucciones de instalación al pie de la letra.
- No utilizar este equipo en zonas residenciales.

Bloqueo/Etiquetado

- Antes de realizar el mantenimiento de los sistemas neumáticos, purgue las líneas para eliminar la presión.
- Bloquee y etiquete todos los sistemas energizados antes de realizar tareas de mantenimiento en ellos. Refiérase a la sección *Pautas de bloqueo/etiquetado* en la página xxvii.

Cómo mantener un entorno seguro

- Mantenga alejados a los niños. Todos los visitantes deben mantenerse a una distancia segura del área de trabajo. Los riesgos pueden no ser evidentes a las personas no familiarizadas con la máquina.
- Mantenga las áreas de trabajo bien iluminadas.
- Mantenga el área de trabajo limpia y libre de cualquier riesgo de tropiezo o resbalamiento.
- No utilice el equipo en lugares húmedos o mojados y no lo exponga a la lluvia o a la nieve.
- Minimice las nubes de polvo y proteja su equipo quitando el polvo de la siguiente manera:

AVISO	
	<p>¡No utilice nunca aire comprimido dentro de una caja eléctrica! Puede forzar sustancias contaminantes hacia el interior de las conexiones eléctricas.</p> <p>Utilice un aspirador para eliminar polvo de las cajas eléctricas. Es aceptable utilizar aire comprimido después de aspirar.</p>

- aspire el polvo antes de soplarlo con aire
- Apague la alimentación eléctrica y todas las fuentes de ignición
- Si usa aire comprimido, debe ser a compresión baja (no más de 15 psi)
- El equipo eléctrico de limpieza como las aspiradoras debe cumplir con los códigos del gobierno local para uso en condiciones polvorientas.

Seguridad

Uso y mantenimiento del equipo

- Asegúrese de que no haya personas, herramientas y objetos extraños en las zonas restringidas antes de utilizar este equipo. Las zonas restringidas se indican en la página xxxii.
- Realice pruebas de seguridad para verificar que todos los frenos de emergencia funcionen adecuadamente antes de utilizar el equipo al principio de la puesta en marcha y después de realizar cualquier tarea de mantenimiento.
- En caso de que la máquina no funcione correctamente, deténgala inmediatamente utilizando un freno de emergencia e informe el problema a un supervisor.
- No deje nunca la máquina encendida si no está junto a ella. ¡Apáguela! No la abandone hasta que todas las piezas se detengan completamente y hasta que se haya apagado la alimentación eléctrica.
- Verifique periódicamente que no haya piezas gastadas o dañadas. Repárelas o cámbielas inmediatamente.
- Mantenga los sistemas neumáticos y eléctricos en buen funcionamiento en todo momento. Repare las fugas y las conexiones sueltas inmediatamente. No exceda nunca la presión ni potencia eléctrica recomendadas.
- Verifique que todos los dispositivos de seguridad estén en buen funcionamiento antes de comenzar cada turno. Todos los dispositivos protectores y de seguridad deben estar en su lugar antes y durante el uso de la máquina. No desconecte ni evite nunca ningún dispositivo de seguridad ni interbloqueo eléctrico.
- Solo el personal de mantenimiento calificado puede quitar o instalar los dispositivos de seguridad.
- Inspeccione periódicamente la calidad del producto terminado.

Seguridad eléctrica

- No utilice líquidos en el interior de los gabinetes eléctricos.
- Cuando utilice disolventes sobre o alrededor de la máquina, desconecte la alimentación para eliminar las probabilidades de chispas, que pueden producir una explosión o incendio. Use un respirador aprobado para el uso con disolventes. Use ropa protectora, guantes y lentes de seguridad.

Bloqueo/Etiquetado

Pautas de bloqueo/etiquetado

Deben cumplir con todas las pautas de bloqueo/ etiquetado conforme a la norma OSHA 29 CFR 1910.147. El programa de control de energía de la compañía debe incluir un procedimiento específico. El objetivo de este manual no es reemplazar el procedimiento de desenergización o bloqueo/etiquetado requerido por la OSHA, sino proporcionar pautas orientativas generales.

El término "bloqueo", según se utiliza en este manual, se refiere a la colocación de un dispositivo de bloqueo en las fuentes de energía para asegurar que el dispositivo aislador de energía y el equipo controlado por éste no puedan reenergizarse o utilizarse hasta que se retire dicho dispositivo. Las fotos en la página xxviii siguiente muestran los lugares en los que se encuentran los interruptores de desconexión eléctrica de esta máquina.

- Las fuentes de energía incluyen energía eléctrica, mecánica, hidráulica, neumática, química, térmica y otras.
- En el caso de fuentes de energía eléctrica, la alimentación principal y la alimentación de control a la maquinaria deben apagarse y bloquearse físicamente en la posición "off" (apagado).
- Por lo general, como dispositivo de bloqueo se utiliza un candado con llave.

Si hay más de una persona trabajando en una zona restringida, utilice un dispositivo de bloqueo grupal que permita a cada persona utilizar un candado que sólo pueda ser retirado por la persona que realiza el mantenimiento.

Siempre que vea este símbolo, ¡Bloquee/Etiquete!

Figura 1-1: Ejemplo de un dispositivo de bloqueo/ etiquetado



Seguridad

Procedimientos de bloqueo/etiquetado eléctricos: fuera del gabinete



Si trabaja en la línea de transmisión eléctrica a la máquina, siga el procedimiento de la página xxix.

Antes de realizar el mantenimiento de cualquier máquina con alimentación eléctrica, bloquee y etiquete la máquina de forma adecuada. Cuando trabaje en una máquina fuera del gabinete eléctrico principal de la máquina, salvo en el caso de trabajos en la línea de transmisión eléctrica a la máquina, siga los procedimientos de bloqueo/etiquetado aprobados por la compañía, los cuales deberían incluir, entre otros, los pasos aquí indicados.

1. Coloque un freno de emergencia sobre la máquina.
2. Coloque el mango del interruptor con fusibles en la posición "apagado". Vea página xxviii.

	 ADVERTENCIA
	RIESGO DE ELECTROCUCIÓN. Cuando el interruptor con fusibles está apagado, sigue habiendo energía dentro del gabinete del interruptor. ¡Apague siempre la alimentación en la fuente de alimentación del edificio antes de abrir este gabinete eléctrico!

3. Coloque un candado y una etiqueta que cumplan con los requisitos de bloqueo/etiquetado de la OSHA.
4. Trabe o desenergice todos los componentes neumáticos y otras piezas que tengan alimentación directa o almacenada.

Figura 1-2: Mecanismo de bloqueo/etiquetado en un gabinete eléctrico principal

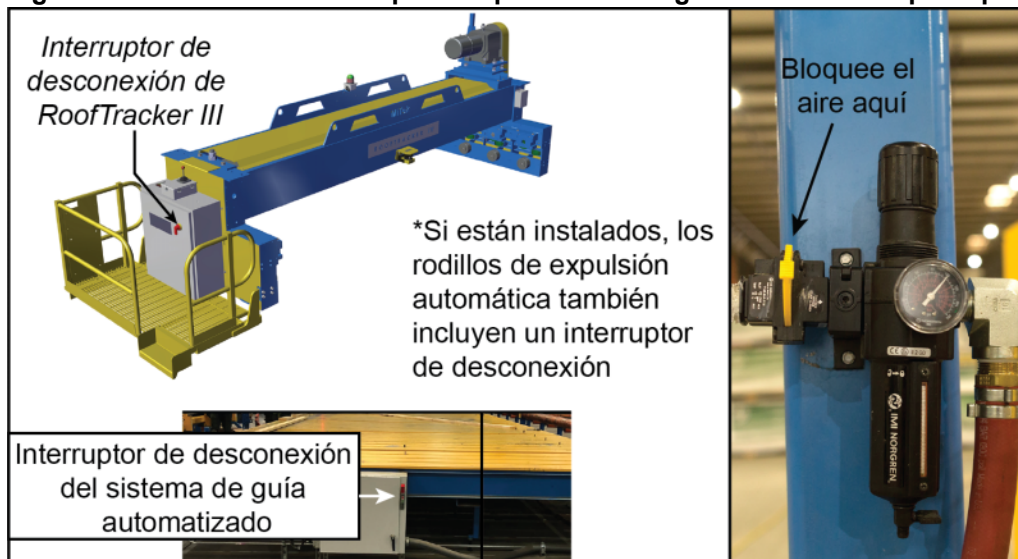

Seguridad



Procedimientos de bloqueo/etiquetado eléctricos: dentro del gabinete

Antes de abrir el gabinete eléctrico principal o intentar reparar o reemplazar una línea de transmisión eléctrica a la máquina, bloquee y etiquete la máquina en forma adecuada. Siga los procedimientos de bloqueo/etiquetado aprobados por la compañía, los cuales deberían incluir, entre otros, los pasos aquí indicados.

1. Coloque un freno de emergencia sobre la máquina.
2. Apague la alimentación a la máquina en la fuente de alimentación, que, por lo general, es un panel de entrada de suministro eléctrico que se encuentra en una pared de las instalaciones. En la Figure 1-3 se muestra un ejemplo de panel de fuente de alimentación bloqueado.
3. Coloque un candado y una etiqueta que cumplan con los requisitos de bloqueo/etiquetado de la OSHA.
4. Abra la puerta del gabinete al que necesita acceder y usando un multímetro verifique que la alimentación esté apagada.

Figura 1-3: Ejemplo de un mecanismo de Bloqueo/Etiquetado en un panel de entrada de suministro eléctrico



Seguridad

Procedimiento de bloqueo/etiquetado del sistema neumático: cuando no se requiere bloqueo/etiquetado

Si trabaja con componentes que no son del sistema neumático pero que requieren su presencia en la proximidad de componentes neumáticos móviles, debe, como mínimo, trabar físicamente estos componentes para que no se muevan. Si no es posible, bloquee/etiquete todo el sistema neumático.



Procedimiento de bloqueo/etiquetado del sistema neumático: cuando se requiere bloqueo/etiquetado

Antes de intentar reparar o realizar el mantenimiento de una línea o componente neumático, bloquee/etiquete la máquina en forma apropiada. Vea la página xxviii para más detalles sobre procedimientos de bloqueo/etiquetado neumático. Siga los procedimientos de bloqueo/etiquetado aprobados por la compañía.

Solución de problemas con una máquina energizada

Sólo un electricista calificado que utilice el equipo de protección personal y siga los procedimientos recomendados en la norma NFPA 70E debe intentar realizar tareas de reparación o mantenimiento en un área o componente energizados de la máquina o en su proximidad.

Cada vez que se realizan tareas de mantenimiento mientras el equipo está eléctricamente energizado, existe un riesgo potencial de formación de un arco eléctrico. Consulte en la norma NFPA 70E el equipo de protección personal requerido para trabajar con componentes eléctricamente energizados. Los componentes neumáticos e hidráulicos pueden moverse de manera imprevista si no se desenergizan. Trabe físicamente cualquier componente que pueda moverse cuando deba trabajar en ellos o en su proximidad.

Prueba de seguridad

Este procedimiento de prueba DEBE ser realizado por personal calificado al momento de la puesta en marcha y después de CUALQUIER tarea de mantenimiento, ajuste o modificación.

1. Asegúrese de que la presión del aire esté ajustada en 100 psi. Vea *Ajuste de la presión*.
2. Accione todos los conjuntos neumáticos para comprobar que suban y bajen según lo previsto a una velocidad razonable.

Zona Restringida



	 PELIGRO
	<p>Manténgase afuera de la zona restringida cuando el equipo esté en uso. Pueden producirse lesiones graves o incluso la muerte si el personal está en la zona restringida.</p> <p>Asegúrese que no haya personal en la zona restringida antes de operar el equipo.</p>

Figura 1-4: Conocer la zona restringida



Marcar la zona restringida

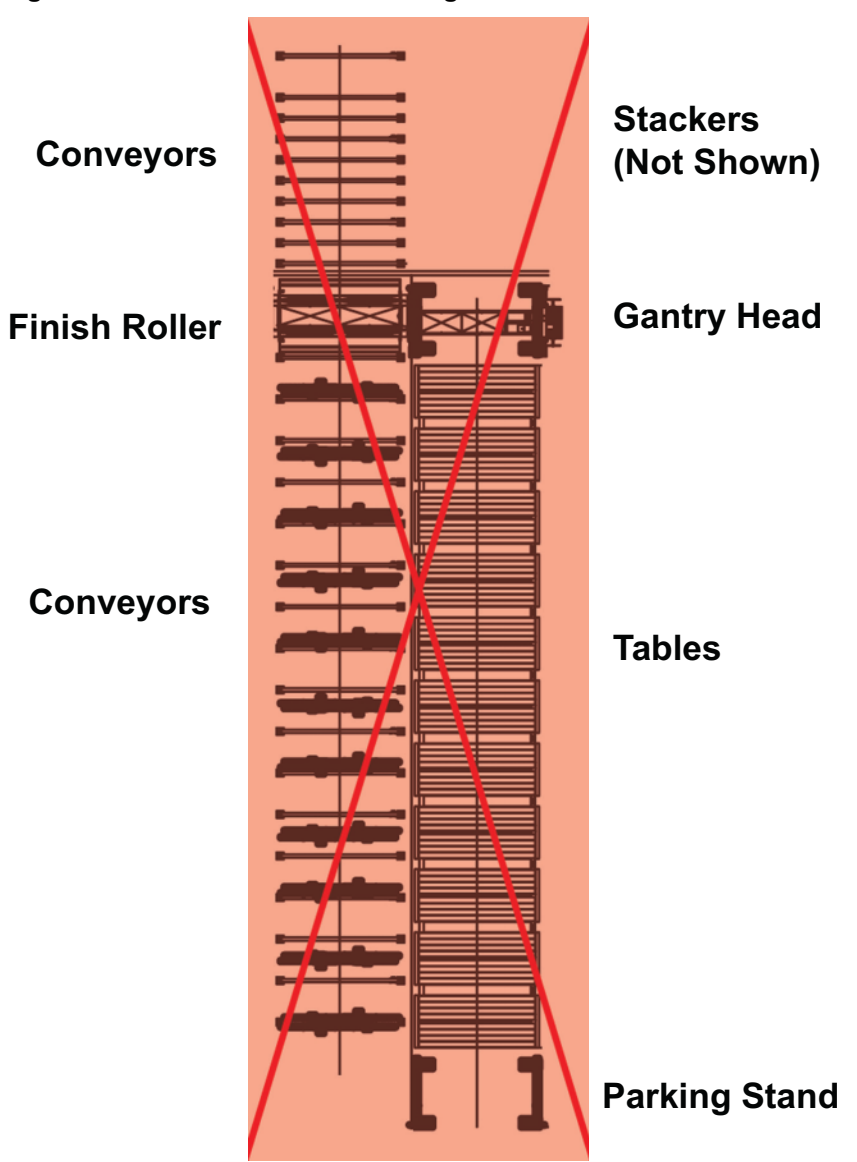

La zona restringida deberá marcarse de tal manera que todas las personas que se encuentren cerca del equipo puedan ver claramente el área donde pueda haber peligro. Vea

Introduction

**Purpose
of Chapter**

This chapter explains how to navigate through the manual and how to contact MiTek Machinery Division Customer Service.

Introduction to the Manual

	 WARNING
	<p>Read this manual completely before using this equipment.</p> <p>Do not operate this equipment until you have a thorough understanding of all controls, safety devices, emergency stops, and operating procedures outlined in this manual.</p> <p>All hazard instructions must be read and observed. Failure to do so may result in economic loss, property damage, and/or personal injury.</p> <p>This manual must always be available to personnel.</p>

Purpose of This Manual

In order for this manual to be useful, it must be accessible.

This manual addresses the most recent version of the equipment as of the date listed on the title page. For earlier revisions, contact MiTek Machinery Division Customer Service.

This manual is a valuable training tool.

- The *Introduction* and *General Information* chapters discuss contact information for MiTek and provide basic information about the equipment.
- The *Operation* chapter teaches operators how to efficiently operate the machine.
- The *Maintenance* chapter details procedures specifically for maintenance personnel.
- The appendices provide valuable training materials and technical information to keep your equipment running.

Introduction

Scope of This Manual

The Roof Truss Table is designed to work with optional accessories and other *MiTek* machines, but the scope of this manual is limited to the following equipment:

Equipment covered in this manual:

- Roof Truss Table
- Ejection Systems (High-Slope Auto-Eject and End-Eject)

Equipment not covered in this manual:

- Roof Press
- Automated or Manual Jigging
- Other peripheral equipment

The Drawing Set





A list of drawings can be found in the back of this equipment manual or in a separate 11x17 binder. The drawings list can be found in the *Drawing Set* chapter.

Introduction

Navigational Aids

The graphics used in Table 1-1 are used throughout the manual to communicate a specific type of information quickly.

Table 1-1: Navigational Aids

Graphic	Explanation
	<p>This icon is an important safety note.</p> <p>It indicates that you must lockout/tagout at the disconnect switch located on the equipment using approved methods described in OSHA CFR 1910.147 before continuing with the procedure.</p>
	<p>This icon specifies that certain tools are needed before a procedure begins.</p>
	<p>This icon provides additional information to supplement the main text.</p>
	<p>This icon indicates how to locate additional relevant information or resources.</p>
	<p>This icon indicates that a part number for the item being discussed is located in the <i>Parts List</i> appendix.</p>

Introduction

Additional Resources

Website

Visit the MiTek website at mitek-us.com for up-to-date information on all MiTek equipment. You may also find the following information there:

- The latest revisions of this manual
- Service bulletins pertaining to your equipment
- Support, safety, and training information
- Part numbers for ordering parts

Phone or E-mail Support

To obtain expert technical assistance or to order parts, contact MiTek Machinery Division Customer Service using one of the following methods.

Contact Information

MiTek Component Automation
Customer Service Department
301 Fountain Lakes Industrial Drive
St. Charles, MO 63301

Parts Orders (with part number)
Email: mitekparts@mii.com

Technical Assistance
Phone: 800-523-3380
Fax: 636-328-9218
machinerysupport@mii.com

Website
mitek-us.com

Videos
Search for “MiTek Inc” to find us on [YouTube](https://www.youtube.com).

General Information

Purpose of Chapter

This chapter provides an overview of the equipment and the means to identify it.

Introduction to the Equipment

Purpose of the Equipment

The Roof Truss Tables are used with *MiTek* roof truss presses. All accessories and options discussed in this manual are designed to work specifically with *MiTek* Roof Truss Tables to make setup and material handling tasks more efficient.

Description of the Equipment

The Roof Truss Tables provide a stable, durable jiggling surface for the assembly and pressing of trusses. Trusses are assembled on the table surface and the press passes above the tables, embedding the plates.

Optional ejection systems can be installed in the tables to lift the trusses off the table for easy removal. Optional automated and manual jiggling can also be installed to drastically reduce setup time.

Safety Compliance of the Equipment

Equipment shipped to a U.S. destination is compliant NFPA 79, NEC 2009, and applicable OSHA regulations.

Equipment shipped to an international destination is compliant with CSA regulations.

General Information

Figure 2-1: Major Components of the Roof Truss Tables (Options Included)

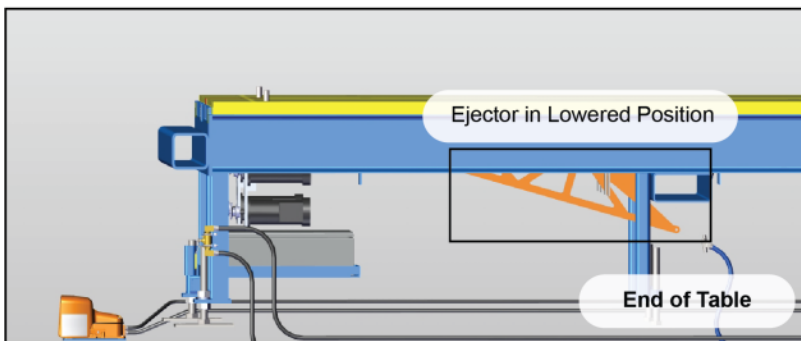
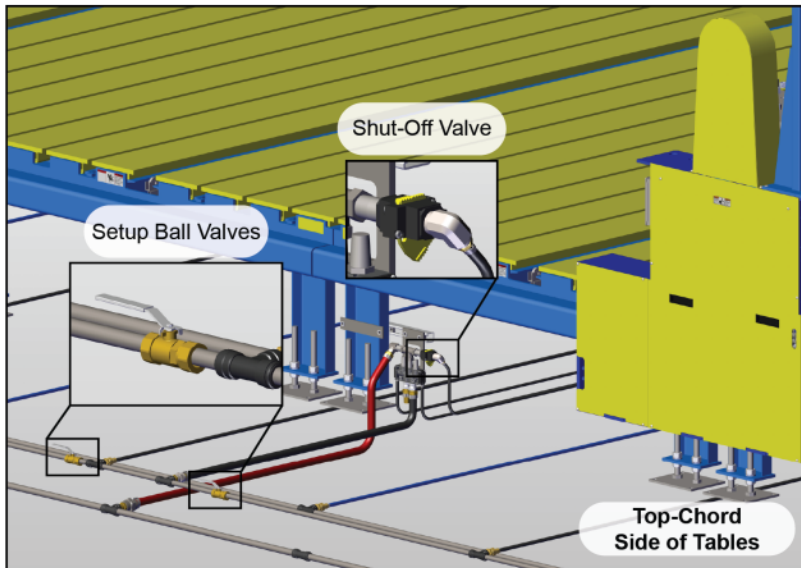
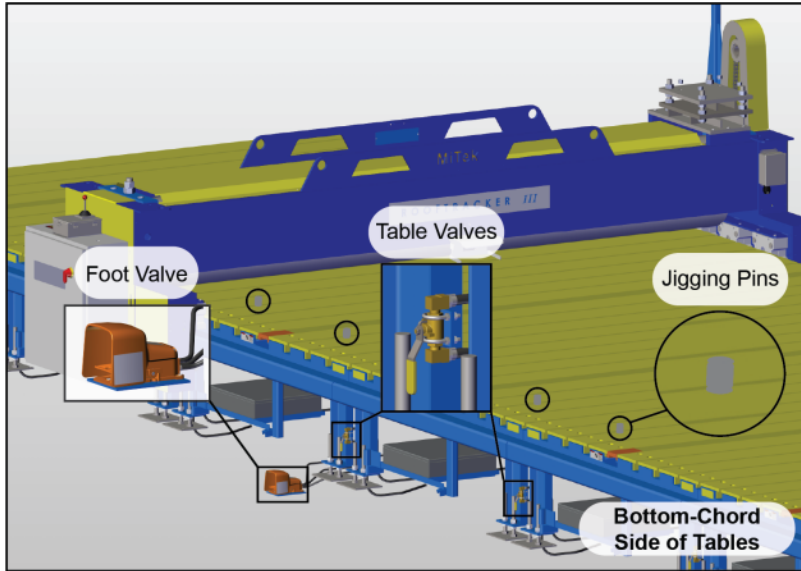

General Information

Components Overview

The main and some of the optional components of the table system are shown on page 6. All optional components are listed in Table 2-1.

Table 2-1: Optional Features

Component	Description
Automated Jigging	See automated jigging equipment manual.
Ejection Systems	High-Slope Auto-Eject (with auto-eject roller) End-Eject (with gantry lifter)
Table Top Surfaces	Walk-through aisles or continuous-top

Technical Specifications

Table 2-2: Dimensions and Weight

Table Type	Dimensions	Approx. Weight
12'-6" Table	13' 4-3/4" L, x 7' 6" W, x 30-3/4" adjustable to 34" H	4,800 lbs
14' Table	14' 10-3/4" L, x 7' 6" W, x 30-3/4" adjustable to 34" H	5,600 lbs
16' Table	16' 10-3/4" L, x 7' 6" W, x 30-3/4" adjustable to 34" H	6,000 lbs

Table 2-3: General Specifications

Table-top material	3/4" steel
Manual jigging slots	6 slots for jigging
Jigging	MiTek-supplied manual jigging is used in manual jigging slots. Automated jigging is optional and can replace manual jigging slots.

Installation

**Purpose
of Chapter**

This chapter provides a brief overview of the responsibilities in the installation process.

Installation Requirements

Environmental Requirements

Operating Temperature

The Roof Gantry Tables operate properly in its intended ambient temperature, from 40 to 122 degrees Fahrenheit (0 to 50 degrees Celsius).

Relative Humidity

The Roof Gantry Tables operate properly in an atmosphere with 45 to 85 percent relative humidity.

Transportation and Storage

The Roof Gantry Tables withstand or has been protected against transportation and storage temperatures from -13 to 158 degrees Fahrenheit (-25 to 70 degrees Celsius). It has been packaged to prevent damage from the effects of normal humidity, vibration, and shock.

	ENVIRONMENTAL
	Do not discard machinery into the municipal waste stream.

Infrastructure Requirements

Flooring Requirements

The Roof Gantry Tables need to be installed on a floor that meets the minimum requirements for the press that will be pressing on the tables. Refer to the press manual.

Installation

Pneumatic Requirements

The Roof Gantry Tables use a pneumatic system to operate optional jiggling components. To reduce condensation in the pneumatic system, MiTek recommends using a refrigerated air dryer. Requirements for the pneumatic system are detailed in Table 3-1.

Table 3-1: Pneumatic System Requirements



Specification	Technical Data
Volume: Auto-Eject End-Eject	.42 scfm per table .39 scfm per table
Pressure	100 psi
Minimum line from air source	1" diameter
Recommended line from air source	1" diameter
Recommended air source tank	min. of 60 gallons

Installation

Responsibilities During Installation

MiTek supervises the installation to ensure that the Roof Gantry Tables are installed properly and operate correctly. MiTek will also provide operating and maintenance training at the time the equipment is installed. The customer is responsible for providing all labor and equipment needed to complete the installation.

Responsibilities Before Moving or Selling

	 WARNING
	<p>Call MiTek Machinery Division Customer Service before moving the system.</p> <p>Moving the system without proper planning may result in equipment damage or serious injury.</p>

If you determine that you want to move your Roof Gantry Tables to another location or you want to sell your system to another company, please call MiTek Machinery Division Customer Service. Customer Service provides detailed information that is needed before installing the system elsewhere.



Customer Service
is available at
800-523-3380.

Marking Restricted Zone

Marking Area on Your Own

The restricted zone must be marked and maintained so everyone near the equipment can clearly see the area where danger may exist. The customer is responsible for marking and maintaining the restricted zone.

Installing MiTek Restricted Zone Tape

Your equipment arrived with Service Bulletin SB181, which includes restricted zone tape and instructions for installing it.

The service bulletin is available online (www.mitek-us.com) as well as through the MiTek Machinery Division Customer Service Department. Follow the instructions contained in SB181 to install the restricted zone tape.

Local Codes and Regulations

The customer must be familiar with all local codes that apply and ensure the equipment is installed in a way that meets these codes. The following list identifies some, but not all, of the items that should be discussed with local authorities.



- Equipment should be stable under all conditions of use, including seismic events
- Fuse and disconnect regulations
- Grounding regulations
- Emissions regulations
- Space required
- Personal protective equipment required
- Inspections required



Operation



**Purpose
of Chapter**

This chapter describes operating mechanisms on this machine and the procedure to operate it in most circumstances.

Before You Begin

	 WARNING
	<p>ELECTROCUTION, HIGH PRESSURE, CRUSH, AND CUT HAZARDS.</p> <p>Read this section AND the safety section in the preliminary pages before operating or maintaining this machine.</p> <p>Do not operate this machine until you have a thorough understanding of all controls, safety devices, E-stops, and operating procedures outlined in this manual.</p> <p>Read and observe all warnings. Failure to do so may result in economic loss, property damage, and/or personal injury.</p> <p>This manual must always be available to personnel operating and maintaining this machine.</p>

	 WARNING
	<p>CRUSH AND CUT HAZARD.</p> <p>Before turning on the machine, make sure that all personnel and other machines are out of the restricted zone (see page xvi).</p>

	 WARNING
	<p>Do not operate this machine unless all guards and safety devices are in place.</p> <p>Only qualified maintenance personnel shall repair, remove, or replace guards and safety devices.</p>

Operation

	⚠ WARNING
	<p>The operation of this machine requires the use of PPE. Do not operate without wearing required protective clothing.</p> <p>Operating this machine without proper PPE may result in injury.</p>

Operator Controls

Refer to your press or automated jigging manual for additional operating information.

Stopping the Machine

Refer to the press manual for instructions on stopping the press and other safety information.

Understanding the Table Components

The pneumatic system controls the optional ejectors on the tables.

Control Valves

This section describes how valves control individual tables or setups. A table line may have multiple setups depending on installation requirements.



Setup (noun):

A section of the pneumatic system configured to act as one unit; it controls the air flow for multiple table ejectors.

1. A foot valve (new models) or hand valve (also referred to as a pilot valve) is used to control a setup. See Figure 4-1.

Figure 4-1: Ejector Control Valves

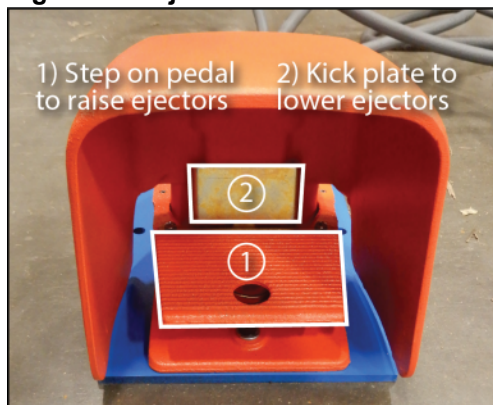

Foot Valve

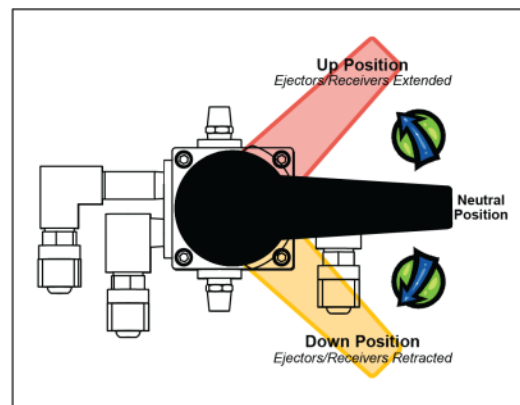

Hand Valve

Operation

- The table valves determine whether the ejectors for an individual table functions within a setup (Figure 4-2).

Figure 4-2: Table Valve

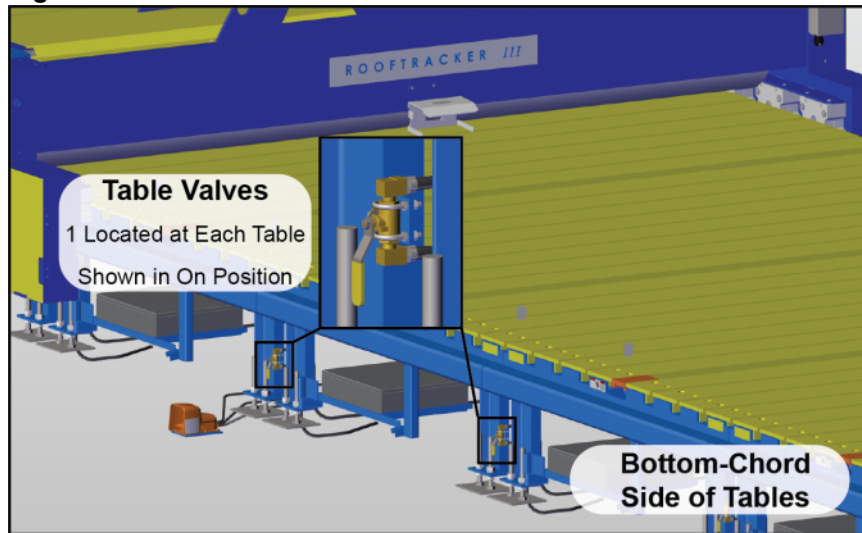

- Ball valves installed in the 22-mm tubing are used to designate where a setup (composed of multiple tables) starts and stops (Figure 4-3).
- The shut-off valve controls air flow to all tables in a setup (Figure 4-3).

Figure 4-3: Setup Ball Valves and Shut-Off Valve

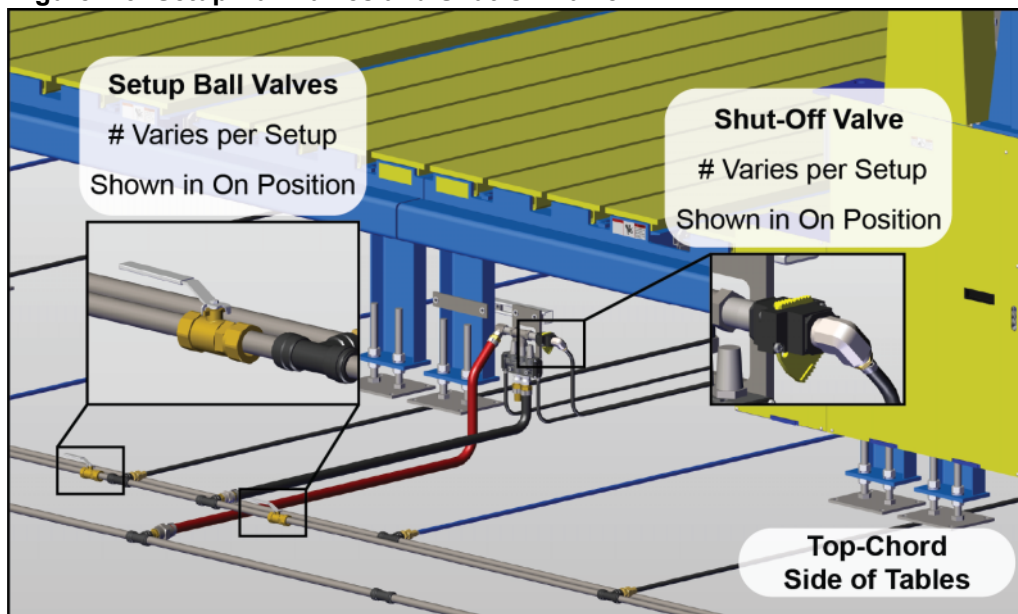



Operation

Operating Procedure

This manual only addresses the use of the Roof Truss Tables. It does not address methods of designing or building a truss or operating the jiggging.

Operating the Tables

	 WARNING
	CRUSH AND CUT HAZARD. Before turning on the equipment, make sure that all personnel and equipment are clear.

1. Set up the truss configuration and jiggging.
Refer to your press manual and jiggging manual.
2. When the press has completed its pass over the truss, park the press head out of the way of the truss.
3. Remove the truss from the table and place it on the Stand-Alone Conveyors.
 - For systems using pneumatic ejectors, refer to the *Operating the Pneumatic Ejection System* section.



Operating the Pneumatic Ejection System

After the connector plates have been pressed into the truss, if pneumatic ejectors are present, take the following steps. These steps may differ according to setup configuration.

1. Ensure the press and/or gantry lift (the machine that lifts the roof press) is in the correct position:
 - For auto-eject systems, the press must be clear of the ejectors.
 - For end-eject systems, the press must be parked on the gantry lift or at the opposite end of the table.
2. Remove ALL slider pads from the tables before actuating ejectors.
 - If, to aid a work flow, you choose not to remove a specific slider pad, make sure to disable the ejector associated with that slider pad to avoid damage to the ejector.
3. Ensure all desired table valves are open.
4. Step on the foot valve (new models) or turn hand valve to the extend position to raise the ejectors.
 - For independent setups:
 - a) Ensure setup ball valves are in correct positions to isolate setup.
 - b) If using a foot valve, ensure the shut-off valve for the chosen setup is open.

Operation

- For operating entire line as one:
 - a) Ensure all setup ball valves are in the open position.
 - b) If using a foot valve, Ensure the shut-off valve connected to the chosen foot valve is open and close all other shut-off valves.
 - c) If using a hand valve, ensure all hand valves are in the neutral position.
- 5. The ejectors lift the truss off the table.

	 WARNING
	CRUSH HAZARD. When removing a truss from an end-eject system, use caution to avoid coming into contact with the Finish Roller. Failure to exercise caution may result in severe personal injury.

- For ejection off the side of the tables, the truss should slide onto the Stand-Alone Conveyors. If auto-eject rollers are present and running, they will automatically assist with this step.
 - On end-eject systems, the pop-up ejectors, the gantry lift, and the press (if parked on the gantry lift) will raise simultaneously. Push or pull the truss across the pop-up ejectors to transfer the truss to the end of the table line.
6. Retract the ejectors back into the table by kicking the foot valve plate (new models) or turning the hand valve to the retract position.

Maintenance

**Purpose
of Chapter**

This chapter provides step-by-step instructions and other information to help you make repairs and perform preventative maintenance.



Performing Maintenance Safely



Read the safety section starting on page vii and adhere to all rules and guidelines. This section provides additional safety information specific to maintenance topics.

The recommended intervals for the maintenance items addressed in this section are listed in *Maintenance Checklist*.



Before Operating This Machine

Review these warnings before operating this machine.

 WARNING	
	<p>HIGH PRESSURE, CRUSH, CUT, AND CHEMICAL HAZARDS</p> <p>Read this section AND the safety section in the preliminary pages before operating or maintaining this equipment.</p> <p>Do not operate this machine until you have a thorough understanding of all controls, safety devices, E-stops, and operating procedures outlined in this manual.</p> <p>Read and observe all hazard instructions. Failure to do so may result in economic loss, property damage, and/or personal injury.</p> <p>This manual must always be available to personnel operating and maintaining this equipment.</p>

 WARNING	
	<p>CRUSH AND CUT HAZARD</p> <p>Guards must always be in place during operation to avoid serious injury and possibly death.</p> <p>Always replace guards after completing maintenance and before removing the lockout/tagout device.</p>



Maintenance

	 WARNING
	<p>CRUSH AND CUT HAZARD.</p> <p>Before turning on the equipment, make sure that all personnel and equipment are clear.</p>

Lockout/Tagout

The lock and tag symbol shown here indicates that proper lockout/tagout procedures must be used prior to starting the procedure where the symbol occurs.



	 WARNING
 	<p>ELECTROCUTION AND HIGH PRESSURE HAZARDS</p> <p>Always turn the power off by activating an E-stop when the equipment is not in operation.</p> <p>Always verify that all power to the machine has been turned off and follow approved lockout/tagout safety procedures (OSHA 29 CFR 1910.147) before performing any maintenance on this equipment.</p> <p>If it is absolutely necessary to troubleshoot an energized machine, follow NFPA 70E or the governing regulations at your location for proper procedures and personal protective equipment.</p> <p>The components on this machine can cause severe injury if adjusted improperly. Follow all procedures in this manual and do not make adjustments to the machine without guidance from MiTek or MiTek documentation.</p> <p>Only trained personnel should make mechanical adjustments to this machine.</p>

Important Safety Information



Your Responsibilities

Detailed descriptions of standard workshop procedures, safety principles, and service operations are not included in this manual. Although this manual contains some warnings and cautions against specific service methods which could cause personal injury or damage to the machine, it does not cover all conceivable ways of service which might be done or the possibility of hazardous consequences of each conceivable way. If you intend to handle, operate, or service the unit by a procedure or method not specifically recommended by the manufacturer, first make sure that such a procedure or method will not render this equipment unsafe or pose a threat to you and others.

It is the responsibility of the mechanic performing the maintenance or service on a particular machine to:

Maintenance

1. Inspect the machine for abnormal wear and damage;
2. Choose a procedure which will not endanger his or her safety, the safety of others, the equipment, or the safe operation of the machine;
3. Fully inspect and test the machine and the hydraulic, pneumatic and electrical systems to ensure that the service to the machine has been properly performed and that the machine, hydraulic, pneumatic and electric systems will function properly; and
4. Ensure only qualified electricians perform electrical service work.

	 WARNING
	This machine uses high-voltage electricity, which may cause serious personal injury or death.

General Service Rules

1. The design may change or upgrades may occur for any particular component. Always contact the factory before replacing components.
2. If inspection or testing reveals evidence of abnormal wear or damage to the machine or if you encounter circumstances not covered in the equipment manual—STOP—and consult MiTek. The machine must be repaired and serviced according to the current specifications and procedures of MiTek, using replacement parts with properties equal to or greater than those specified by MiTek.
3. Use the correct tools and procedures on this machine, to avoid damage and incorrect assembly.

	NOTICE
	Never use compressed air inside an electrical enclosure. It may force contaminants into electrical connections. Use a vacuum to remove dust from electrical enclosures. Canned air is acceptable after vacuuming.



4. Always install new gaskets, O-rings, cotter pins, etc., and place Loctite on bolts, if required.
5. Torque bolts and fasteners to the correct specifications.
6. Clean parts in a nonflammable or high-flash-point solvent only.
7. Lubricate any sliding surfaces before assembly.
8. Many components are manufactured from high carbon, heat-treated steel. Do not attempt to cold straighten, hot straighten, bend, or weld these components, as they may fail under load causing serious personal injury or death.

Maintenance

9. After re-assembly, check all parts for proper installation and operation before putting the machine back into service.
10. It is beneficial to record all major maintenance and testing. This allows recurring problems to be predicted and addressed before any production time is lost. Typical reports and records should include:
 - Date
 - Serial number of machine
 - Description of problems or symptoms
 - Corrective action taken
 - Parts required
11. MiTek will, from time to time, mail out service bulletins and updates for this machine. Follow the service bulletins and updates accordingly and file them in this equipment manual.

Making Adjustments and Replacing Parts

Be careful when making mechanical adjustments. Untrained personnel may damage the machine or cause harm to themselves and others.



	 WARNING
	CRUSH AND CUT HAZARDS Always replace guards after servicing. Only qualified maintenance personnel shall repair, remove, or replace guards and safety devices.

	NOTICE
	Failure to follow the step-by-step procedures in this chapter may result in incorrect adjustment of this machine. Only trained maintenance personnel should make mechanical adjustments to this machine. Use only the exact replacement parts specified in this manual.

Special materials have been used for some of the components of this equipment. It is critical to the future performance of this machine that only specified replacement parts are used. Order all replacement parts through MiTek. Do not substitute parts without first consulting MiTek to determine if it is safe and effective. No electrical system component, cable, connector, or device should be modified, removed, disconnected, changed without specific approval and guidance from MiTek.

Maintenance

Wearing Personal Protective Equipment

	 CAUTION
	<p>Follow OSHA guidelines to utilize the proper personal protective equipment (PPE) while performing maintenance.</p> <p>The most common include eye protection, hearing protection, dust masks while blowing off sawdust, gloves while working with solvents, and fire retardant clothing when troubleshooting an energized machine.</p>

Testing the Safety of the Machine

The test procedure in the *Safety* section starting on page xv **MUST** be performed by qualified personnel after ANY maintenance, adjustment, or modification.

The test should be performed before each shift starts to make sure that the safety features remain in working order.



Cleaning and Inspecting

Cleaning



If it should become necessary to clean this machine, disconnect it from its power source first. Do not use liquid cleaners, aerosols, abrasive pads, scouring powders or solvents, such as benzene or alcohol. Use a soft cloth lightly moistened with a mild detergent solution. Make sure the surface cleaned is fully dry before reconnecting power.

Use pneumatic air to regularly blow dust and debris off of the tables, ejection components, and rollers. Make sure truss plates or other sharp objects are clear of all pneumatic and electrical systems.

	 CAUTION
	<p>CRUSH AND CUT HAZARD</p> <p>Always replace guards after completing maintenance and before removing the lockout/tagout device.</p> <p>Operating a machine with guards removed may result in serious injury or death.</p>

	NOTICE
	<p>Never use compressed air inside of electrical enclosures. It may force contaminants into electrical connections.</p> <p>Use a vacuum to remove dust from electrical enclosures. Canned air is acceptable after vacuuming.</p>

Maintenance

Inspecting the Ejectors





Check the clevis pin in the bell crank and all bolts for wear every three (3) months. Check bumpers on the high-slope auto-ejectors for wear or damage and replace as needed. See *High Slope Ejector Bumpers* for the location of each ejector bumper and replacement instructions. If bumpers are not replaced, the link arm's pivot holes will wallow out and cause premature failure. Replace all other worn parts.

Inspecting the Ejection System as a Whole

Check that the tables are level with the auto-eject rollers on an annual basis.

Pneumatic System Maintenance

The pneumatic system controls the ejectors on the tables and the receiver stands (if present).

 CAUTION	
	<p>HIGH PRESSURE HAZARD.</p> <p>Bleed all pressure from pneumatic lines before performing maintenance on pneumatic components.</p> <p>Pressurized components may move suddenly or vent air to atmosphere, causing injury.</p>

Removing Pressure from the Pneumatic System

Most procedures involving the pneumatic system require the removal of pressure. Use the following procedure to remove pressure from the system.

1. Prepare the pneumatic system to remove pressure:
 - a) In systems with foot valves (new models), ensure all shut-off valves are in the open position.
 - b) In systems with hand valves, ensure all hand valves are in the neutral position.
2. Push the system shut-off valve on the filter/regulator assembly to the lockout position so it cuts off air flow. See Figure 5-1.
3. Lockout/tagout through the hole on the yellow slide. See Figure 5-1.
4. Check the air pressure gauge reads 0 psi and actuate an ejector control valve (the ejectors should not raise) to make sure all pressure has been bled from the system.

Maintenance

Filter/Regulator

The filter/regulator can be purchased directly from MiTek. Refer to the *Parts List* chapter for instructions on ordering parts.

WARNING	
	<p>HIGH PRESSURE HAZARD.</p> <p>To avoid injury, bleed all pressure from the lines before removing the filter guard.</p> <p>Ensure that the filter guard is securely attached to the regulator body before returning pressure to the lines.</p>

Replacing the Filter Element



The regulator uses a 40-micron filter element that must be replaced every six (6) months. This filter can be purchased from MiTek. Refer to the *Parts List* chapter for instructions on ordering parts.

1. When replacing the filter element, the system must be free of pressure. To depressurize the system see *Removing Pressure from the Pneumatic System*.
2. Remove the bowl from the regulator body by turning it in the direction indicated by unlock/lock label while pushing up on the bowl. Then pull down and remove the bowl from the body.
3. Unscrew the white end-cap and remove the old filter element.
4. Install the new filter element and screw the white end-cap into place.
5. Place the bowl back onto the regulator body by pushing up and turning it in the direction indicated by unlock/lock label. Make sure it is securely attached before returning pressure to the lines.

Figure 5-1: Filter/Regulator

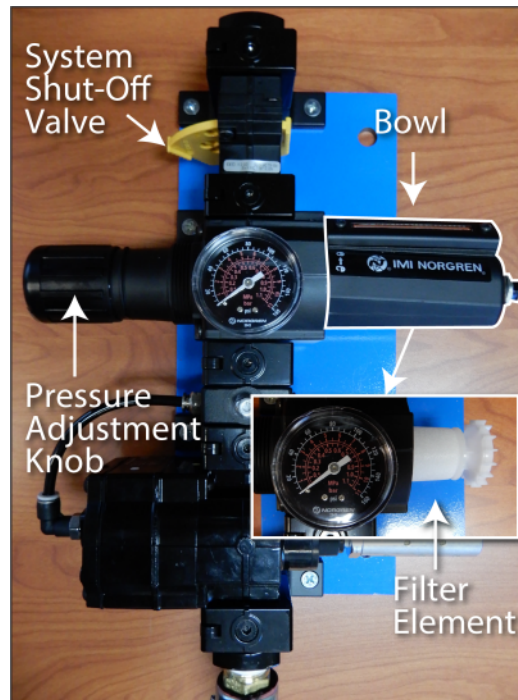

Adjusting the Pressure

The operating pressure of the pneumatic system should be 100 psi. The pressure adjustment knob shown in Figure 5-1 controls the operating pressure. Do not adjust this knob to change the speed of the ejectors and receivers. Adjustments to individual cylinders can be made using the flow control valves on each cylinder. Refer to the *Cylinders* section for this procedure.

Maintenance

To adjust the system pressure to 100 psi:

1. Unlock the pressure adjustment knob on the filter/regulator by pulling it straight up.
2. Turn the knob clockwise to increase pressure or counterclockwise to decrease pressure.
3. Once a pressure of 100 psi is achieved, push the knob down to lock it in place.

Manual Drain

The latest model of the filter/regulator automatically drains accumulated liquid. Previous models of the filter/regulator require manual draining. At the bottom of the filter/regulator is a thumbscrew that operates a drain. When condensation gathers in pneumatic lines, it will show in the bowl's sight glass. Where the sight glass comes in contact with water, it turns red, indicating the water level. Open this drain periodically to drain fluid from the system.



Additional Maintenance

If a filter/regulator is not operating at its optimum capacity, we recommend cleaning the regulator and replacing the O-rings, gaskets, diaphragm, and valve assembly. Refer to the *Parts List* chapter for instructions on ordering parts.

Setup Valve

Each setup has one setup valve that controls the air flow to the setup. The air entering the setup valve is controlled by the foot valve (new models) or hand valve in each setup. There are no controls on the setup valve assembly itself.

Preventive maintenance for the setup valve consists of replacing the O-rings, seals, and valve head gasket when the quality of the air pressure begins to diminish. Refer to the *Parts List* chapter for instructions on ordering parts.



Figure 5-2: Setup Valve

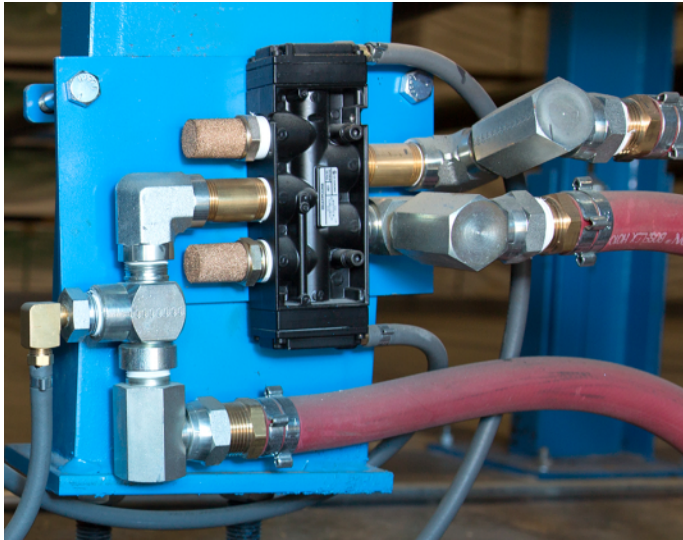

Maintenance

Control Valves

Foot Valve

A foot valve (new models) controls the air flow for one setup. If you experience any issues with a foot valve, contact MiTek Machinery Division Customer Service. See *Contact Information*.

Hand Valve

A hand valve (if present) controls the air flow for one setup. Each hand valve is mounted on the bottom-chord end of one table.

If the handle on the hand valve breaks, remove the shoulder screw and replace the handle.

A service kit is available to replace the seals, valve inserts, springs, etc. when needed. To reach these components, remove the four (4) small screws on the front of the valve assembly and move the valve assembly away from the blue anchor plate. Unscrew the two (2) screws on the back side and remove the oval plate. Refer to the *Parts List* chapter for instructions on ordering parts.

Figure 5-3: Hand Valve

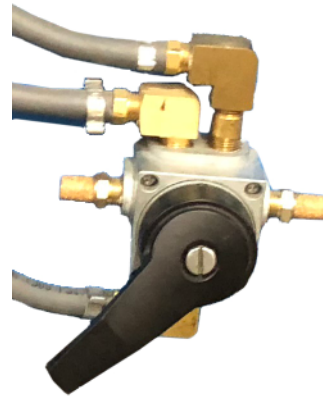

Maintenance

Ejector Cylinders

Adjusting Cushion Valves

Some cylinders have adjustable cushion valves to decelerate the load and reduce potentially destructive energy. These cushion valves sometimes need fine tuning to find their ideal cushioning between the completely closed and completely open positions.

- A completely closed cushion valve causes the cylinder to slow abruptly near the end of its stroke, increasing the cycle time.
- A completely open cushion valve prevents the cylinder from decelerating the load, producing a jarring end impact.

If cylinders with cushion valves are not adjusted properly, adjust the cushion valve using the following steps.



1. Lockout/tagout the pneumatic system and drain the lines of pressure in order to prevent cylinder motion.
2. Slide underneath the table.
3. Turn the adjusting screw clockwise until the valve is completely closed. See Figure 5-4 for location of screw.
4. Turn the adjusting screw counterclockwise a 1/2 turn.
5. Slide out from underneath the table and re-pressurize the system.
6. Actuate the cylinder using a normal load at normal speed.
7. Repeat steps 4-6 until the cylinder decelerates the load without the increased cycle time that occurs with a completely closed valve or the jarring end impact that occurs with a completely open valve.
 - You may need to fine-tune the cylinder by 1/8 turns when you approach ideal cushioning.
 - Failure to properly maintain and calibrated the cushion valves may shorten the lifespan of the cylinders.

Figure 5-4: Adjusting Table Cylinders

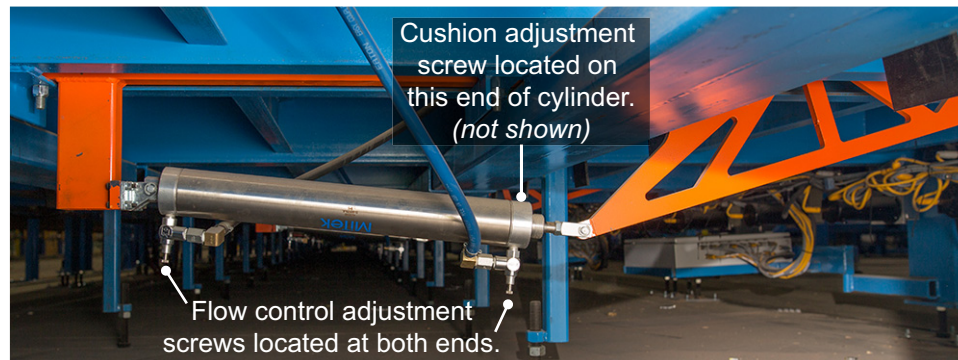

Maintenance

Adjusting Flow Control Valves



Both ends of some cylinders have flow control valves that control the speed at which the ejectors extend and retract. Adjust the flow control so that there is a smooth extend and retract motion and all ejectors raise at approximately the same time. Failure to correctly adjust the ejectors may lead to premature wear and damage to assembled trusses.

The location of the flow control valve that needs adjustment depends on whether the cylinder is moving too quickly on the extending or retracting stroke. See Figure 5-4.

Stroke	valve location	increase speed	decrease speed
Extend	Rod end of cylinder	Turn the adjusting screw counterclockwise	Turn the adjusting screw clockwise
Retract	Cap end of cylinder	Turn the adjusting screw counterclockwise	Turn the adjusting screw clockwise

If a customer experiences cylinder responsiveness issues on a longer table line, *MiTek* recommends adding a second air supply source to the opposite table end to help with air flow management.

High Slope Ejector Bumpers

A visible degree of indentation on the bumpers is normal, but any bumpers showing visible cracks should be replaced immediately. *MiTek* recommends keeping ejector bumpers in stock, but if none are available, refer to the *Parts List* chapter for instructions on ordering parts. The locations of the ejector bumpers are identified in Figure 5-5.

Figure 5-5: Ejector Bumper Locations

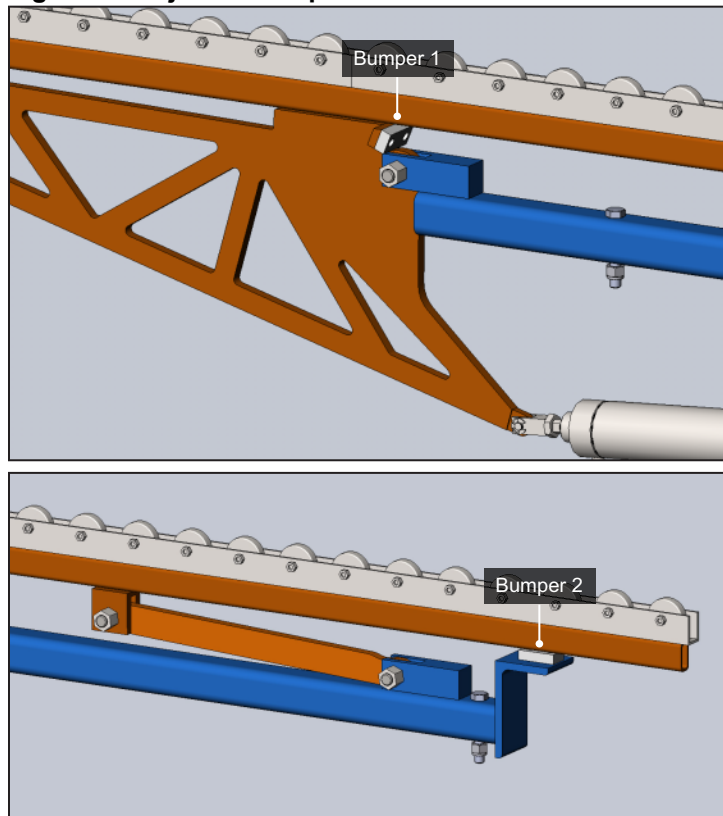

Maintenance

Replacing a Ejector Bumper



1. Lockout/tagout the pneumatic system. See *Removing Pressure from the Pneumatic System*.
2. Once pressure has been removed from the pneumatic system, the ejectors should move freely. Use a board or other sturdy material to wedge the ejectors in an upward position to allow access to the bumpers.
3. Use a hex key to loosen the bolts securing the bumper and remove it.
4. Use a hex key to secure the new bumper using the existing bolts.
5. Remove the material used to wedge the ejectors into an upward position to ensure the ejectors can move freely.



Troubleshooting

**Purpose
of Appendix**

This appendix describes possible problems and solutions that you may encounter while operating the Roof Truss Tables.

Safety Notes for Troubleshooting

General Troubleshooting Safety Tips

 WARNING	
	<p>ELECTROCUTION, HIGH PRESSURE, CRUSH, CUT, AND CHEMICAL HAZARDS.</p> <p>Read all notes in this section AND the safety section in the preliminary pages before operating or maintaining this equipment.</p> <p>Most solutions are described in more detail in the <i>Maintenance</i> chapter, where there may be additional safety notes.</p>

- Read all warnings located in the safety section in the preliminary pages and adhere to them at all times.
- When the blue lock shown in the margin appears, lockout/tagout at the disconnect switch located on the equipment using approved methods described in OSHA 29 CFR 1910.147 before continuing with the procedure or troubleshooting.
- If the lockout/tagout graphic does not appear, it is recommended that you still de-energize the machine unless energy is required for the troubleshooting process. If it is absolutely necessary to troubleshoot an energized machine, follow NFPA 70E for proper procedures and personal protective equipment.
- All electrical work must be performed by a licensed electrician.
- Read this manual for information and procedures related to the specific maintenance or troubleshooting issue before attempting any maintenance.
- Safety goggles and a dust mask must be worn for all cleaning steps outlined in this manual. When using cleaning and lubrication solutions, a respirator rated for use with those solutions must be worn, as well as gloves resistant to the solution.



Troubleshooting

Electrical Troubleshooting Safety Tips

- Make sure that you have the proper tools for the job. See page 31.
- Make sure that the person performing the troubleshooting is qualified from an electrical knowledge standpoint. If you feel uncertain about troubleshooting electrical power, remember that the cost of an injury far outweighs the cost of hiring an electrician.
- Remove rings or watches. They are extremely conductive material and may catch on small components.
- Get a helper. You are most likely going to need an extra hand at some point, and you shouldn't perform electrical work without someone close by to help if you get injured.
- Be patient. Take your time and stay alert. Never take shortcuts or become too confident in what you are doing.
- Take notes recording what you have checked and what the readings were. This is a good way to check your work when you are finished. Sometimes, the machine won't work because a wire was removed for testing and overlooked when cleaning up. Having notes makes the process go much more smoothly.
- ALWAYS turn the power off if you are checking for ohms or swapping PLC cards.
- ALWAYS push an E-stop button before approaching a machine for any reason. If you are working on encoders, pushing an E-stop is especially important. An interruption to a powered encoder may cause components to move without warning.
- Wear appropriate PPE (personal protective equipment) for working with live power.

Getting Started with Troubleshooting

Tools Required

When the toolbox shown in the margin appears, you should gather the tools listed below it before beginning the procedure next to which it appears.



Before beginning the troubleshooting process or calling MiTek Machinery Division Customer Service, gather the following tools:

- Insulated slotted screwdriver
- Insulated Phillips screwdriver
- Equipment manual and drawings, including any electrical schematics
- Pen and notepad
- Multimeter

A multimeter is an electronic measuring instrument. The analog versions were referred to as a volt-ohm-meter (VOM). Digital models are referred to as digital multimeters (DMM). Your multimeter should have the following features:

- Voltage (volts) measurement
- Resistance (ohms) measurement
- Current (amps) measurement
- Ability to measure both AC and DC power
- Autoranging feature
- PPE as required by NFPA 70e

Troubleshooting

First Steps

Mechanical Troubleshooting

Always clean and lubricate the equipment as a first step in most troubleshooting processes. Most mechanical malfunctions are caused by inadequate preventative maintenance.



Electrical Troubleshooting

1. Lockout/tagout at the disconnect switch located on the equipment.

	NOTICE
	Never use compressed air inside an electrical enclosure. It may force contaminants into electrical connections. Use a vacuum to remove dust from electrical enclosures. Canned air is acceptable after vacuuming.



2. Vacuum and dust the electrical enclosure.
3. Remove the lockout/tagout equipment and attempt to run the Roof Truss Tables again. If that did not solve the problem, proceed with the next step.
4. Adhere to all regulations and guidelines given in NFPA 70e and in your company's energy control program. Some important safety tips are addressed on page 29.

	 WARNING
	ELECTRICUTION HAZARD. All electrical work must be performed by a licensed electrician. If it is absolutely necessary to troubleshoot an energized machine, follow appropriate guidelines.

5. Determine where the electrical problem begins. To do this, you need a multimeter.
 - Determine if you are working with AC (alternating current) or DC (direct current) before checking voltage.
 - Measure incoming and outgoing voltage to and from components. Proceed in a logical order determined by your machine's specific problem, and write down the order that you check each component and the amount of voltage that the multimeter registers.

Troubleshooting

Problems and Solutions

Table A-1: Troubleshooting the Pneumatic System

Problem	Possible Cause	Possible Solution	See Page
End fitting blown off of hose	Improper assembly procedures, improper skiving, incorrect hose-end series, mixing competitor's components with Weatherhead® components	Ensure that the hose-end is the correct fitting and is properly installed; never intermix components	
Hose end appears to have been pinched on one side	Collet is becoming worn	Replace the collet	
Hose has burst or cracked	Abrasion, hose is twisted or kinked	Remove possible abrasives and twists or kinks in the hose	
	Excessive pressure	Check pressure relief for damage or improper setting	
	Hose puncture by truss plate	Check for damage and replace hose	
Receivers and ejectors not actuating at same time	Flow controls need adjustment	Adjust flow controls on receiver or lifter cylinder	22
One table in setup not working (receiver and ejector)	Table valve shut off	Open table valve	15
	Table isolated from rest of setup	Ensure 22-mm ball valve on secondary header is open between table and setup	
The ejectors and receivers on one setup do not function with the other setups when operating entire system together	The hand valve for the setup that is not operating correctly is shut off	If using foot valve, check shut-off valves are properly configured. If using hand valve, move to the neutral position when operating the entire system as one setup	15
Ejectors do not have enough power to lift truss off table	System pressure set too low	Increase pressure regulator to recommended 100 psi	23
	Air loss in system	Check all connections and hoses for air leaks	
Air leak at 22-m or 28-mm aluminum tube fittings	Loose connection	Ensure system is depressurized. Disconnect tube from fitting and re-connect	
	O-ring damaged	Replace fitting and remove burrs and sharp edges from tube	
	Loose connection	Ensure system is depressurized. Disconnect hose and ensure hose has clean 90° cut	
Air leak in hose	Hose damaged	Replace hose; ensure area is free and clear of debris including nail plates	

Parts List

**Purpose
of Appendix**

This appendix lists MiTek replacement part numbers for your Roof Truss Tables.

Ordering Parts

Use the MiTek web site to locate parts and part numbers, then order them using one of these methods:

By E-Mail
Send an e-mail to mitekparts@mii.com with all relevant information, including the part number.

By Phone
Call 1-800-523-3380.

Stocking Spare Parts



This appendix lists the names of the parts that should be kept in stock at your facility to greatly reduce maintenance down-time.

Safety Notes for Replacement Parts

	NOTICE
	<p>Use only parts purchased from MiTek to replace parts on your Roof Truss Tables.</p> <p>Parts from other sources may damage your Roof Truss Tables.</p>

	WARNING
	<p>ELECTRICAL HAZARD.</p> <p>All electrical work must be performed by a licensed electrician.</p> <p>Follow approved lockout/tagout procedures (OSHA 29 CFR 1910.147)</p>

Parts List

	 WARNING
	ELECTROCUTION AND HIGH PRESSURE HAZARDS. Always turn the power off by activating an E-stop when the machine is not operating.
	Always verify that all power to the machine is off and followed approved lockout/tagout procedures (OSHA 29 CFR 1910.147) before performing any maintenance. Turn off the air switch or shutoff valve if appropriate. Bleed pneumatic lines if appropriate.

List of Parts to Keep in Stock

Keep one of each of these parts in stock.

1. Ball valve assembly (tees, connectors, and hoses)
2. Cylinder assembly receivers (cylinder, connectors, and hoses)
3. Cylinder assembly tables (cylinder, connectors, and hoses)
4. Filter/regulator (filter element for regulator)
5. Setup Valve Assembly (tees, connectors, and hoses)



Maintenance Checklist



Purpose of Appendix This appendix consists of checklists to plan and record preventative maintenance procedures.

Using the Maintenance Checklists

Copy these checklists and place the copies with the Roof Truss Tables. Leave the original checklists in this manual for future use.

Safety Notes for the Maintenance Checklists



	 WARNING
	<p>HAZARD.</p> <p>Perform the safety tests described in “Safety Tests” on page xv or “Prueba de seguridad” on page xxxi before operating the machine after performing maintenance or repairs.</p>

	 WARNING
 	<p>ELECTROCUTION AND HIGH PRESSURE HAZARDS.</p> <p>Always turn the power off by activating an E-stop when the machine is not operating.</p> <p>Always verify that all power to the machine is off and followed approved lockout/tagout procedures (OSHA 29 CFR 1910.147) before performing any maintenance.</p> <p>Bleed all pressure from pneumatic lines before performing maintenance on pneumatic components.</p> <p>Pressurized components may move suddenly or vent air to atmosphere, causing injury.</p>

Maintenance Checklist

Checklist

Year _____

	 WARNING
	<p>Lockout/tagout before performing maintenance.</p> <p>If power is required, make sure all personnel are clear of the restricted zone.</p>

Action	Frequency		Page	Initials / Date				
	1-shift	2-shifts						
Check filter/regulator filter	Every 2 weeks	Every 2 weeks	23					
Replace filter/regulator filter	Every 6 months	Every 6 months	23					
Check Setup Valves	Every year	Every year	24					
Check that the tables, receiver stands, and auto-eject rollers are level (for systems with those options)	Every year	Every year	22					
Observe the operation of ejectors and repair as needed.	Every 3 months	Every 3 months	26					
Check the condition of high slope ejector bumpers and replace as needed	Every 3 months	Every 3 months	27					
Purchase and install new filter/regulator service kits	Every 2 years	Every year	23					

Date	Notes

Drawing Set

Purpose of Appendix This appendix consists of a list of schematics and other drawings to help you understand and troubleshoot your machine.

Drawings are inserted in the back of the manual or included in a separate binder, depending on the machine.

Description	Drawing Number
Base Air Kit Assembly	31340-501
Filter / Regulator Assembly	31340-601
Foot / Setup Valve Assembly	31345-501
Auto Eject Assembly (high-sloped side ejection, with auto-eject roller)	31220-501
End-Eject Assembly	31290-501
Table Cylinder Assembly	84883-501

Document Evaluation

**Purpose
of Appendix**

This appendix provides a form so that you may evaluate this manual.

MiTek Machinery Division makes a continuous effort to provide customers with helpful, accurate documentation.

Please complete this form to provide us with comments or suggestions that improve the quality of our documentation.

Document Evaluation

Document Evaluation Form

Roof Gantry Tables	Operation and Maintenance Manual	001090 rev. C
--------------------	----------------------------------	---------------

General Evaluation

	Poor	fair	good	excellent
Content				
Organization				
Accuracy				
Clarity				
Completeness				
Illustrations				
Readability				

Specific Evaluation

Identify any inaccuracies in this manual. Please include page numbers.	
What are the best features of this manual?	
What are the worst features of this manual?	
Name:	Date:
Company:	Address:
Phone:	E-mail:
Return the form by mail: MiTek Machinery Division 301 Fountain Lakes Industrial Drive Saint Charles, MO 63301 Attn: Engineering Manager	Return this form by fax: 636-328-9218 Attn: Engineering Manager
If you do not receive a reply within 45 days, please call Machinery Division Customer Service and ask for the documentation specialist or engineering manager.	

Glossary

Purpose of Appendix

This appendix provides definitions of terminology that apply to your machine.

actuate	to activate, put into action
affected employee	an employee whose job requires him or her to operate or use a machine or equipment on which servicing or maintenance is being performed under lockout or tagout, or whose job requires him or her to work in an area in which such servicing or maintenance is being performed
aisle pad	a type of jiggging used when a connector plate needs to be embedded where the table surface gives way to a walk-through aisle
amperage	the strength of an electric current, expressed in amperes
anchor plate	a steel plate that holds the tables in place; it is anchored to the concrete floor and the tables are welded to it
authorized employee	a person who locks out or tags out a machine or equipment in order to perform servicing or maintenance on that machine or equipment; an affected employee becomes an authorized employee when that employee's duties include performing servicing or maintenance covered under this section
auto-eject	a pneumatic system that raises the truss off the tables and automatically places the truss on the stand-alone conveyors, may work in tandem with an auto-eject roller
beacon	a light that displays one of several colors to represent the state of the machine
bus bar	an electrical device that allows multiple gantry heads to be used simultaneously
connector plate	the nail-plate that is embedded into production material to hold it together
cushion	an attribute of a hydraulic cylinder that allows for adjustment of pressure at the end of a stroke

Glossary

end-eject	a pneumatic system that raises the truss off the tables and allows the truss to be manually pushed or pulled off the end of the tables; this system requires that the gantry head rolls back over the truss or a device must be installed to raise the gantry head when it is parked
energized	connected to an energy source or containing residual or stored energy
energy isolating device	a mechanical device that physically prevents the transmission or release of energy, including but not limited to the following: manually operated electrical circuit breaker; a disconnect switch; a manually operated switch by which the conductors of a circuit can be disconnected from all ungrounded supply conductors, and in addition, no circuit can be operated independently; a line valve; a block; and any similar device used to block or isolate energy—push buttons, selector switches, and other control circuit type devices are not energy isolating devices
energy source	any source of electrical, mechanical, hydraulic, pneumatic, chemical, thermal, or other energy
foot valve	a pneumatic foot valve that operates the setup valve to control the release or cessation of air in each setup; it is located on the bottom-chord end of one table in each setup.
gantry head	the entire traveling weldment that houses a roller to embed connector plates
jigging	any of several devices used to hold the truss in place on the tables
laser scanner	a safety device that monitors a defined area in front of a machine for obstructions, slows the machine when it detects a distant obstruction, and triggers an E-stop when it detects a nearby obstruction
layout	a scaled diagram of the location of components and the space that they occupy
leveling screws	large cap head screws that thread into the table legs and allow the table height to be adjusted and leveled
light bar	a perimeter access guarding device used on some models that uses multiple light beams to detect when something is in the way of the gantry head and stops the machine to prevent injury or damage
lockout device	a device that utilizes a positive means such as a lock, either key or combination type, to hold an energy isolating device in the safe position and prevent the energizing of a machine or equipment, including blank flanges and bolted slip blinds; should be standardized within the facility in at least one of the following criteria: color; shape; or size; and additionally, in the case of tagout devices, print and format shall be standardized

Glossary

lockout/tagout	a means of isolating a piece of equipment from its energy source so maintenance can safely occur; guidelines provided in OSHA 29 CFR 1910.147
motor end	used to indicate which end of the gantry head is being discussed; the end of the gantry head that houses the motor
operator control interface	the method in which the operator controls the machine; it may be a touch screen, a control panel, etc.
outer side	refers to the end of the gantry head housing; the side farthest from the tables; both ends have an outer side—one can see the outer side of the one end when standing at the pendant control station
pilot valve	see <i>hand valve</i>
plate	see <i>connector plate</i>
PLC	(programmable logic controller) a solid-state control device that can be programmed to control process or machine operations. It consists of five basic components: processor, memory, input/output module, the power supply, and the programming device.
port	a connection point for a peripheral device
potentiometer	a control knob that is a dial; allows a range of values to be set by turning the dial, commonly found on the PLC
proximity switch	a switch that uses an electromagnetic field to detect when an object is near, there is no physical contact between the object and the switch; inductive proximity switches detect only metal objects, capacitive proximity switches can sense both metallic and non-metallic objects
puck	a type of jiggling that is small and round
qualified person	a person or persons who, by possession of a recognized degree or certificate of professional training, or who, by extensive knowledge, training, or experience, has successfully demonstrated the ability to solve problems relating to the subject matter and work—ANSI B30.2-1983; one who has skills and knowledge related to the construction and operation of the electrical equipment and installations and has received safety training on the hazards involved—NEC2002 Handbook
receiver bar	the light bar that receives the signal from the transmitter bar; every light bar set consists of a receiver bar and a transmitter bar
regulator	a component of the pneumatic system that connects to the main air source and regulates the air pressure allowed into the system
roller	the large roller inside the gantry head that innately embeds the plates into the truss

Glossary

scanner	<i>see laser scanner</i>
hand valve	a pneumatic valve that operates the setup valve to control the release or cessation of air in each setup; it is located on the bottom-chord end of one table in each setup.
setup valve	a component of the pneumatic system that control the flow of air to the rest of the setup, controlled by the hand valve
shut-off valve	a valve in the setup valve assembly that controls air flow to all tables in a setup
slider pad	a type of jiggging used when a connector plate needs to be embedded where the table surface gives way to a slot for the ejector
solenoid	an assembly used as a switch consisting of a coil and a metal core free to slide along the coil axis under the influence of the magnetic field
stand-alone conveyor	the conveyor system that carries the truss from the tables to the Finish Roller and out to the stacker
stop	a type of jiggging that is long and straight
tagout device	a prominent warning device, such as a tag and a means of attachment, which can be securely fastened to an energy isolating device in accordance with an established procedure, to indicate that the energy isolating device and the equipment being controlled may not be operated until the tagout device is removed; should be standardized within the facility in at least one of the following criteria: color; shape; or size; and additionally, in the case of tagout devices, print and format shall be standardized
take-up bearing	adjusts the height of the roller
torque	a turning or twisting force
auto-eject roller	a motorized roller sitting perpendicular to the tables on an auto-eject system; it automatically transfers the truss from the Ejectors to the stand-alone conveyors
transmitter bar	the light bar that transmits the signal to the receiver bar; every light bar set consists of a receiver bar and a transmitter bar
VFD	(variable frequency drive) controls the speed of a cycle
voltage	Equal to the difference of electric potential between two point on a conducting wire carrying a constant current of one ampere when the power between the points is one watt

Index

Purpose of Appendix

This appendix consists of an index to assist in navigating the manual.

A

- air hose
 - troubleshooting 33
- air pressure, adjusting regulator 23

C

- checklists
 - maintenance 36
 - weekly checklist 37
- controls *see* operator controls
- corrections ii
- cushion valves *see* pneumatic system
- customer service 4
- cylinders
 - cushion valves 26
 - flow control valves 27

D

- document evaluation 40

E

- ejectors
 - troubleshooting 33
- e-mail support *see* customer service
- emergency stop *see* E-stop
- errors ii
- E-stop 13
- evaluation of document 40

F

- filter/regulator 23
 - replacement 23
- flow control valves *see* pneumatic system

G

- graphics 6

L

- lockout/tagout
 - electrical procedure xii, xiii
 - pneumatic procedure xiv
 - pneumatic system 22
 - procedure xxviii
 - symbol 18
- lubricator 22

M

- Machinery Division Customer Service 4

maintenance

- checklists 36
- safety 17

manual

- introduction 1
- navigation 3
- purpose 1, 2

- manual evaluation *see* document evaluation
- marking restricted zone 10

O

- oil, lubricator 22
- operating procedure 15
- operation
 - quick start procedure 15
 - stopping 13
- operator controls 13

P

- parts list 34
- phone support *see* customer service
- pilot valve, *see* setup pilot valve 25
- pneumatic system
 - air leak 33
 - cylinders
 - cushion valves 26
 - flow control valves 27
 - filter/regulator
 - maintenance 23
 - lubricator, maintenance 22
 - maintenance 22, 23
 - removing pressure 22
 - system pressure, adjusting 23
 - troubleshooting 33
- purpose of manual 1, 2

R

- receivers
 - troubleshooting 33
- replacement parts *see* parts list
- restricted zone xvi, 10
- return goods ii

S

- safety
 - conformity xxi
 - during troubleshooting 29
 - general rules viii

Index

- indicators vii
- lockout/tagout xi
- marking restricted zone xvi
- restricted zone xvi
- safety test xxxi
- signal words vii
- symbols xvii
- tests xv
- troubleshooting with energy xiv
- safety signs *see* safety symbols
- setup
 - troubleshooting 33
- setup pilot valve 25
- spare parts *see* parts list
- stop motion *see* E-stop
- support *see* customer service