

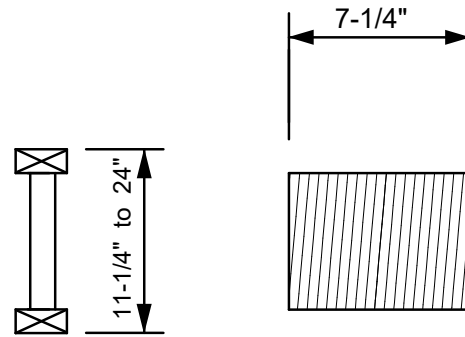

SEE THE MiTek TRUSS DESIGN
REFERENCING THIS DETAIL
FOR ADDITIONAL DESIGN INFORMATION

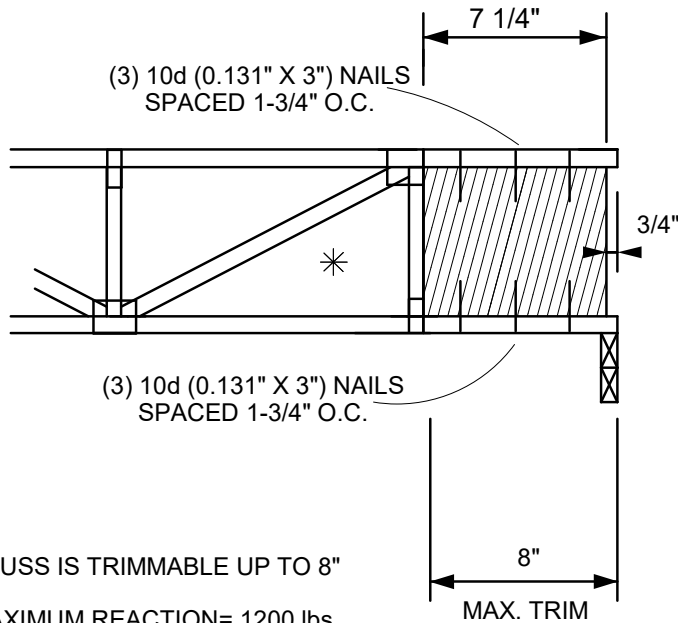

2x8 VERTICAL BLOCK
No.2 or Better: SPF, SP, DF or HF

TRUSS IS TRIMMABLE UP TO 8"
MAXIMUM REACTION= 1200 lbs
MINIMUM BEARING SIZE IS 1-3/4"

* LAST DIAGONAL WEB MUST BE RAN UP TO THE TOP CHORD AS SHOWN