

MiTek USA, Inc.

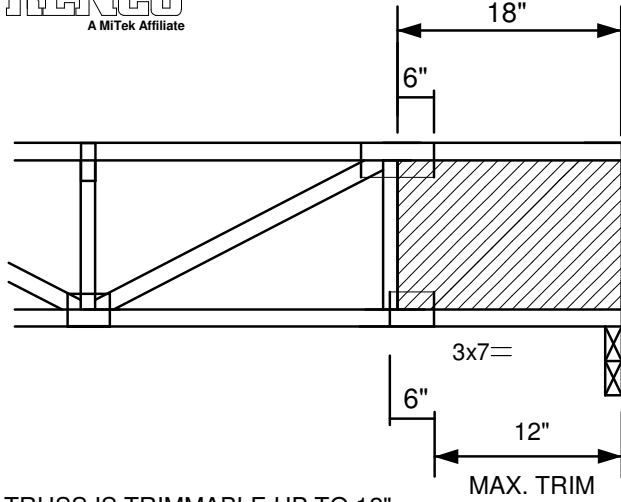

SEE THE MiTek TRUSS DESIGN
REFERENCING THIS DETAIL
FOR ADDITIONAL DESIGN INFORMATION



8-1/4" to 21" DEEP PSL
PLATED IN PLANE OF TRUSS

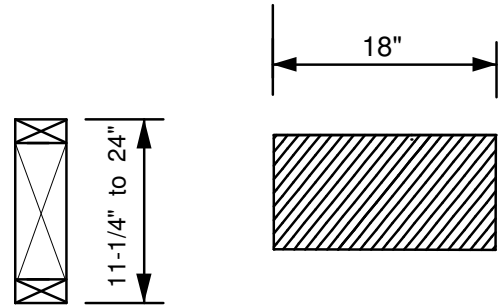

TRUSS IS TRIMMABLE UP TO 12"

MINIMUM BEARING SIZE IS 1-3/4"

MAX REACTION = 1320 lbs

PSL: Parallel Strand Lumber as described in ICC-ES Evaluation Report ESR-1387