

SEE THE MiTek TRUSS DESIGN  
REFERENCING THIS DETAIL  
FOR ADDITIONAL DESIGN INFORMATION

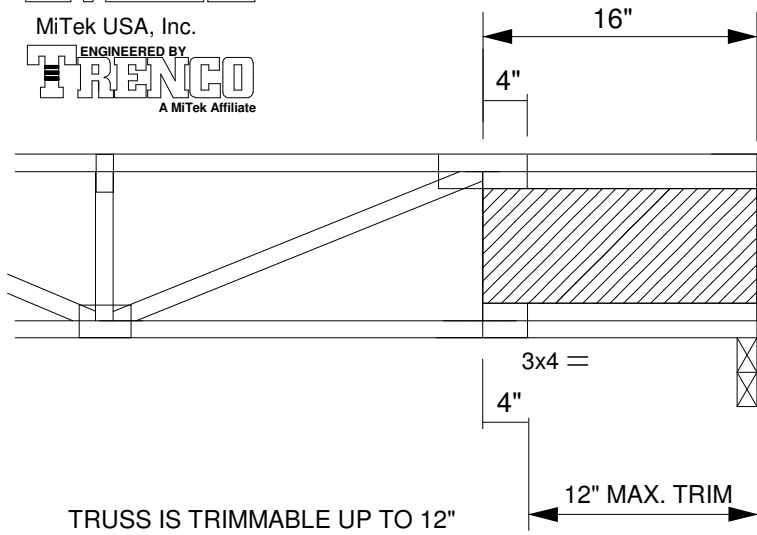

8-1/4" to 21"  
TRIM FIT I-BLOCK  
PLATED IN PLANE OF TRUSS

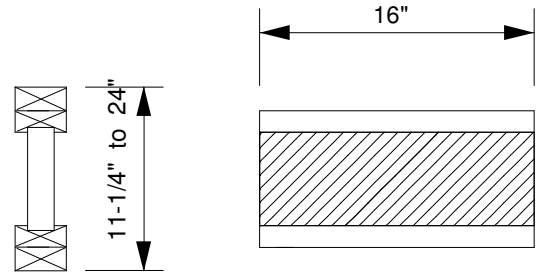

TRUSS IS TRIMMABLE UP TO 12"

MINIMUM BEARING SIZE IS 1-3/4"

FLANGES ARE SPF (MINIMUM)

Ft 3x2 = 535 psi 4x2 = 382 psi

MAX REACTION FOR 1-3/4" TO 3-1/2" BRG.	
DEPTH	SPF
11-1/4"	1033 lbs
11-7/8"	1129 lbs
12"	1148 lbs
14"	1454 lbs
16" - 24"	1499 lbs