

# Operation Manual



## Cyber<sup>®</sup> A/T

Component Cutting Saw

# Operation Manual

# Cyber<sup>®</sup> A/T

Component Cutting Saw



*U.S. and other patents pending.*

001055-OP

**MiTek**  
**Machinery Division**  
**301 Fountain Lakes Industrial Dr.**  
**St. Charles, MO 63301**  
**phone: 800-523-3380**  
**fax: 636-328-9218**  
**www.mii.com**

|               |                              |
|---------------|------------------------------|
| Entire manual | 001055                       |
| Date created  | 2002                         |
| Revision      | D                            |
| Revision date | 06/21/07                     |
| Revised by    | R. Tucker                    |
| Approved by   | G. McNeelege<br>G. Pritchett |
| Applicability | 60000-xxx                    |
| Effectivity   | Frame 412, 10/04             |
| Print date    | 1/11/24                      |

# Legal Notice

## Patents

Made and sold under one or more of the following patents:

U.S. 6,539,830

U.S. 6,702,096

Other Patents Pending

## Return Goods Policy

Return goods cannot be accepted without prior authorization and are subject to a restocking charge. The Seller certifies the articles specified herein were produced in compliance with all provisions of the Fair Labor Standards Act of 1938, as amended, including Section 12.—Rev. 6/98

## Reporting Errors and Recommending Improvements

To report errors or recommend improvements to this manual, please complete the Document Evaluation Form in the appendices. Mail or fax the form to:

MiTek, Machinery Division  
301 Fountain Lakes Industrial Drive  
St. Charles, MO 63301  
Attn: Engineering Manager  
Fax: 636-328-9218

Your support in helping MiTek provide unsurpassed machinery and support is appreciated.

# Notice of Change

Use this page to record Service Bulletins and Notices that you receive to keep your manual updated.

**Equipment Manual**  
**Cyber<sup>®</sup> A/T Saw**

| Service Bulletin or Notice # | Dated | Title |
|------------------------------|-------|-------|
|                              |       |       |
|                              |       |       |
|                              |       |       |
|                              |       |       |
|                              |       |       |
|                              |       |       |
|                              |       |       |
|                              |       |       |
|                              |       |       |
|                              |       |       |
|                              |       |       |
|                              |       |       |
|                              |       |       |
|                              |       |       |
|                              |       |       |

# Table of Contents

## Preliminary Pages

|                            |     |
|----------------------------|-----|
| Legal Notice . . . . .     | ii  |
| Notice of Change . . . . . | iii |

## Safety (English)

|  |              |
|--|--------------|
| <b>Safety Indicators</b> . . . . .                         | <b>OP-2</b>  |
| <b>Safety Rules</b> . . . . .                              | <b>OP-3</b>  |
| <b>Lockout/Tagout</b> . . . . .                            | <b>OP-5</b>  |
| Lockout/Tagout Guidelines . . . . .                        | OP-5         |
| Electrical Lockout/Tagout Procedures . . . . .             | OP-6         |
| Pneumatic System Lockout/Tagout Procedure . . . . .        | OP-9         |
| <b>Troubleshooting With an Energized Machine</b> . . . . . | <b>OP-9</b>  |
| <b>Restricted Zone</b> . . . . .                           | <b>OP-10</b> |
| <b>Safety Test</b> . . . . .                               | <b>OP-12</b> |
| Testing Emergency Stops (E-Stops) . . . . .                | OP-12        |
| Checking Saw Blades . . . . .                              | OP-13        |
| Inspecting the Saw . . . . .                               | OP-14        |

## Seguridad (Español)

|   |              |
|---|--------------|
| <b>Indicadores de seguridad</b> . . . . .                           | <b>OP-16</b> |
| <b>Reglas de seguridad</b> . . . . .                                | <b>OP-17</b> |
| <b>Bloqueo/Etiquetado</b> . . . . .                                 | <b>OP-20</b> |
| Pautas de bloqueo/etiquetado . . . . .                              | OP-20        |
| Procedimientos de bloqueo/etiquetado eléctricos . . . . .           | OP-21        |
| Procedimiento de bloqueo/etiquetado del sistema neumático . . . . . | OP-24        |
| <b>Solución de problemas con una máquina energizada</b> . . . . .   | <b>OP-25</b> |
| <b>Zonas restringida</b> . . . . .                                  | <b>OP-26</b> |
| <b>Prueba de seguridad</b> . . . . .                                | <b>OP-28</b> |
| Prueba de frenos de emergencia . . . . .                            | OP-28        |
| Verificación de las hojas de la sierra . . . . .                    | OP-29        |
| Inspección de la sierra . . . . .                                   | OP-30        |

## Introduction

### Chapter 1

|   |              |
|---|--------------|
| <b>Introduction to the Equipment Manual</b> . . . . . | <b>OP-31</b> |
| Purpose and Scope of This Equipment Manual . . . . .  | OP-31        |
| Graphics Used to Help Navigate . . . . .              | OP-32        |
| Using This Manual . . . . .                           | OP-33        |
| Screen Shots . . . . .                                | OP-34        |
| <b>Contacting MiTek</b> . . . . .                     | <b>OP-34</b> |

## General Information

### Chapter 2

|  |              |
|--|--------------|
| <b>Introduction to the Equipment</b> . . . . . | <b>OP-35</b> |
| Purpose of the Equipment . . . . .             | OP-35        |
| Description of the Equipment . . . . .         | OP-35        |
| <b>Features</b> . . . . .                      | <b>OP-36</b> |
| <b>Variations and Options</b> . . . . .        | <b>OP-37</b> |

# Table of Contents

|  |                  |
|--|------------------|
| General Specifications .....                                   | OP-38            |
| Truss Terminology .....  | OP-39            |
| <b>Operation</b>   | <b>Chapter 3</b> |
| <b>Navigation</b> .....  | <b>OP-41</b>     |
| Navigating the Operation Chapter .....                         | OP-41            |
| Navigating Windows Software Without a Mouse .....              | OP-42            |
| <b>Operation Part 1:</b>                                       |                  |
| <b>Introduction to the Equipment</b> .....                     | <b>OP-43</b>     |
| <b>Quad and Blade Numbers</b> .....                            | <b>OP-43</b>     |
| <b>Safety Test Requirements</b> .....                          | <b>OP-43</b>     |
| <b>Emergency Stopping Methods</b> .....                        | <b>OP-43</b>     |
| Overview of Emergency Stops (E-Stops) .....                    | OP-44            |
| E-Stop Pushbuttons .....                                       | OP-45            |
| Perimeter Safety Cable (Pull-Cord) .....                       | OP-45            |
| Swing Guard E-Stop Actuator .....                              | OP-45            |
| Disconnect Switches .....                                      | OP-45            |
| <b>Tips for Using the Operator Control Interface</b> .....     | <b>OP-46</b>     |
| Using the Touch Screen .....                                   | OP-46            |
| Getting Familiar With the Software .....                       | OP-47            |
| <b>Operation Part 2:</b>                                       |                  |
| <b>Operating Procedures</b> .....                              | <b>OP-48</b>     |
| <b>Quick Start: An Operating Overview</b> .....                | <b>OP-48</b>     |
| <b>Using the Manual and Semiauto Screens</b> .....             | <b>OP-51</b>     |
| Entering Numerical Data .....                                  | OP-51            |
| Operating Procedure in Manual and Semiauto Mode .....          | OP-52            |
| <b>Operating Procedures: Daily Startup</b> .....               | <b>OP-53</b>     |
| Turning On the Saw .....                                       | OP-53            |
| Turning On the Computer and Monitor .....                      | OP-53            |
| <b>Pre-Operation Safety Check</b> .....                        | <b>OP-56</b>     |
| Safety Tests .....   | OP-56            |
| Performing Daily Maintenance .....                             | OP-56            |
| Clearing E-Stops and Faults .....                              | OP-56            |
| <b>Operating Procedures: Setup</b> .....                       | <b>OP-57</b>     |
| Loading and Deleting Batch Cutting Files .....                 | OP-57            |
| Setting Infeed Conveyor Offset .....                           | OP-58            |
| <b>Operating Procedures: Using Supports</b> .....              | <b>OP-59</b>     |
| Using the Center Lumber Support .....                          | OP-59            |
| Using the Heel Cut Skid Bar .....                              | OP-60            |
| Using the Floor Truss Web Riser Bars .....                     | OP-61            |
| <b>Operating Procedures: Begin Sawing</b> .....                | <b>OP-63</b>     |
| <b>Operating Procedures: Feeding and Removing Lumber</b> ..... | <b>OP-64</b>     |
| Direction of Lumber .....                                      | OP-64            |
| Tips for Faster Feeding .....                                  | OP-65            |
| How to Feed the Lumber .....                                   | OP-66            |

# Table of Contents

|  |              |
|--|--------------|
| How to Remove the Lumber at the Outfeed Side .....   | OP-67        |
| <b>Other Operating Procedures .....</b>              | <b>OP-68</b> |
| Choosing Which Member to Cut .....                   | OP-68        |
| Choosing Which Batch to Cut .....                    | OP-68        |
| Setting the Infeed Conveyor Offset .....             | OP-68        |
| Starting the Blades .....                            | OP-69        |
| Operating a MiTek Inker or Catcher Display .....     | OP-69        |
| Resetting Alarms and Faults .....                    | OP-69        |
| Selecting a Language for the Software .....          | OP-69        |
| <b>Adjustments During Operation .....</b>            | <b>OP-70</b> |
| Adjusting the Centerline or Angle of a Saw .....     | OP-70        |
| Adjusting the Position of the Infeed Conveyors ..... | OP-71        |
| Adjusting the Position of the Hold-Down .....        | OP-71        |
| Adjusting the Position of the Carriage .....         | OP-72        |
| Adjusting the Position of the Lumber Stop .....      | OP-72        |
| Changing Lumber Size .....                           | OP-72        |
| Adjusting the Speed of the Infeed Conveyors .....    | OP-73        |
| Moving a Blade In- or Out-of-Cut .....               | OP-73        |
| <b>Overfeeding .....</b>                             | <b>OP-74</b> |
| <b>Operating Procedures: Shutting Down .....</b>     | <b>OP-74</b> |
| Turning Off the Saw .....                            | OP-74        |
| Shutting Down the Computer and Monitor .....         | OP-75        |
| <b>Operation Part 3:</b>                             |              |
| <b>Software Screens .....</b>                        | <b>OP-76</b> |
| <b>Main Menu .....</b>                               | <b>OP-76</b> |
| Looking Up the Project Software Version .....        | OP-76        |
| Alarms Status Bar .....                              | OP-76        |
| Main Menu Buttons .....                              | OP-77        |
| <b>Alarms Status Bar .....</b>                       | <b>OP-78</b> |
| <b>Manual Screen .....</b>                           | <b>OP-79</b> |
| Overview .....                                       | OP-79        |
| Sub-Menus Accessed From the Manual Screen .....      | OP-81        |
| <b>Semiautomatic (Semiauto) Screen .....</b>         | <b>OP-83</b> |
| Overview .....                                       | OP-83        |
| Sub-Menus Accessed From the Semiauto Screen .....    | OP-86        |
| <b>Automatic Screen .....</b>                        | <b>OP-87</b> |
| Overview .....                                       | OP-87        |
| Sub-Menus Accessed From the Semiauto Screen .....    | OP-89        |
| Sub-Menus Accessed From the More Screen .....        | OP-90        |
| <b>Default Screens .....</b>                         | <b>OP-93</b> |
| <b>Alarm Conditions Menu .....</b>                   | <b>OP-97</b> |
| Maintenance Record Screens .....                     | OP-109       |
| Reports Screens .....                                | OP-110       |
| Calibration Screen .....                             | OP-110       |
| <b>Operation Part 4:</b>                             |              |

# Table of Contents

|  |               |
|--|---------------|
| Sample Cuts .....                          | OP-111        |
| Sample Cut #1: Bottom Chord .....          | OP-111        |
| Sample Cut #2: Top Chord .....             | OP-113        |
| Sample Cut #3: Roof Truss Web .....        | OP-115        |
| Sample Cut #4: Floor Truss Web .....       | OP-117        |
| Sample Cut #5: Scissors Bottom Chord ..... | OP-119        |
| Operation Part 5:                          |               |
| Angle and Slope Conversion Chart .....     | OP-121        |
| <b>Index</b>                               | <b>OP-123</b> |



# **Safety (English)**

For safety information in Spanish, refer to page MT-15.

**Be Careful.  
Be Safe.**



## Safety Indicators

The following safety alert symbols and signal words are used throughout this document to indicate safety hazards. Please pay careful attention when you see them. The level of severity differs for each symbol or signal word.

Failure to comply with the instructions accompanying each safety alert symbol may result in property damage, personal injury, or even death. Personnel must follow all safety procedures and practices to ensure the safest possible operation of this equipment. However, at no time is this document a substitute for common sense. Personnel must ensure that the work environment is safe and free of distractions.



### **DANGER**

Indicates an imminently hazardous situation which, if not avoided, is likely to result in death or serious injury.



### **WARNING**

Indicates a potentially hazardous situation which, if not avoided, may result in death or serious injury.



### **CAUTION**

When CAUTION is used **with** the safety alert symbol shown here, it indicates a potentially hazardous situation which, if not avoided, may result in minor or moderate injury.

When CAUTION is used **without** the safety alert symbol shown here, it indicates a potentially hazardous situation which may result in equipment damage.

**NOTICE**

### **NOTICE**

Calls attention to information that is significant to understanding the operation at hand.

**ENVIRONMENTAL**

### **ENVIRONMENTAL**

Applies to conditions that may affect the environment but do not have an immediate, direct effect on personnel or equipment.

## Safety Rules

Because it is impossible to anticipate every circumstance that might involve a hazard, the safety information provided in this equipment manual and on the machine is not all-inclusive. If this machine is operated or serviced using a procedure not specifically recommended by the manufacturer, the procedure shall be approved by a professional engineer to ensure it will not render the equipment unsafe. Use extreme caution and common sense at all times!

### Know Your Equipment

- Read this manual completely before using or maintaining the equipment. Do not operate this machine unless you have a thorough knowledge of the controls, safety devices, emergency stops, and operating procedures outlined in this manual.
- Read and follow all safety notes. Failure to comply with these instructions may result in economic loss, property damage, and/or personal injury including death.
- Refer to the lockout/tagout guidelines on the following pages to safely perform maintenance and troubleshooting of this equipment.
- Observe and obey all safety labels. Replace worn labels immediately.
- Use this equipment solely for the purpose described in this manual.
- Only qualified personnel should attempt to operate or perform maintenance on this equipment. “Qualified personnel” is defined as:

*...a person or persons who, by possession of a recognized degree or certificate of professional training, or who, by extensive knowledge, training, or experience, has successfully demonstrated the ability to solve problems relating to the subject matter and work—ANSI B30.2-1983*

*...one who has skills and knowledge related to the construction and operation of the electrical equipment and installations and has received safety training on the hazards involved—NEC 2002 Handbook*

### Personal Safety

- Always wear safety glasses and hearing protection in an industrial environment.
- Utilize a filtering facepiece (dust mask) when working near sawdust.
- Wear proper clothing and appropriate personal protective equipment (e.g., safety glasses and hearing protection.) Do not wear loose clothing or jewelry. Confine long hair by tying it back.
- Use caution when lifting heavy parts or material.

### Installing the Equipment

- Follow installation instructions completely.

### **Lockout/Tagout**

- Before performing maintenance on the pneumatic or hydraulic systems, bleed the lines to eliminate pressure.
- Lockout/tagout all energized systems before performing maintenance on them. Refer to the *Lockout/Tagout Guidelines* section on page 5.

### **Keeping a Safe Environment**

- Keep children away. All visitors should be kept a safe distance from the work area. Hazards may not be apparent to individuals unfamiliar with the machine.
- Keep work areas well lit.
- Keep the work area clean and free of any trip or slip hazards.
- Do not use the equipment in damp or wet locations, or expose it to rain or snow.

### **Operating and Maintaining the Equipment**

- Ensure that all people, tools, and foreign objects are clear of the restricted zones before operating this equipment. The restricted zones are shown on page MT-10.
- Perform the safety tests recommended in the Safety Test section on page 12 before operating the equipment at the initial startup, after performing any maintenance, and in accordance with the maintenance schedule.
- In case of machine malfunction, stop the machine immediately using an E-stop and report the malfunction to a supervisor.
- Never leave the machine running unattended. Turn the power off! Do not leave the machine until all parts have come to a complete stop and all electrical power has been shut off.
- Check for worn or damaged parts regularly. Repair or replace them immediately.
- Keep the hydraulic, pneumatic, and electrical systems in good working order at all times. Repair leaks and loose connections immediately. Never exceed the recommended pressure or electrical power.
- Check that all safety devices are in working order before each shift starts. All protective guards and safety devices must be in place before and during use of the machine. Never disconnect or bypass any safety device or electrical interlock.
- Periodically inspect the quality of the finished product.

### **Electrical Safety**

- Do not use any liquids in the interior of electrical cabinets.
- When using solvents on and around the machine, remove power to the machine to eliminate the chance of sparking, resulting in explosion or fire. Wear a respirator approved for use with solvents. Wear protective clothing, gloves, and safety glasses.

## Lockout/Tagout

### Lockout/Tagout Guidelines

**All lockout/tagout guidelines must be met according to OSHA 29 CFR 1910.147.** A specific procedure should be included in your company's energy control program. This manual is not intended to replace your company's de-energizing or lockout/tagout procedure required by OSHA, but merely to provide general guidance.

The term "lockout," as used in this manual, means placing a lockout device on any and all energy sources to ensure that the energy isolating device and the equipment being controlled cannot be re-energized or operated until the lockout device is removed. The photos on the next page show where the electrical disconnects are located for this machine.



- Energy sources include electrical, mechanical, hydraulic, pneumatic, chemical, thermal, or other energy.
- In the case of electrical energy sources, the main power and control power to the machinery must be turned off and physically locked in the "off" position.
- A lockout device is usually a keyed padlock.
- If more than one person is working in a restricted zone, use a group lockout device that will allow each person to use a lock that can be removed only by the person performing the maintenance.

"Tagout" means that a prominent warning is securely fastened to an energy-isolating device to indicate that the equipment shall not be operated.

## Electrical Lockout/Tagout Procedures

### When Working on a Machine Outside the Machine's Main Electrical Enclosure



If working on the electrical transmission line to the machine, follow the procedure on page 8.

Before performing maintenance on any machine with electrical power, lockout/tagout the machine properly. When working on a machine outside of the machine's main electrical enclosure, not including work on the electrical transmission line to the machine, follow your company's approved lockout/tagout procedures which should include, but are not limited to the steps here.

1. Engage an E-stop on the machine.
2. Turn the disconnect switch handle on the machine's main electrical enclosure to the "off" position. See Figure SAFETY-1.

| <b>WARNING</b>  |  |
|---|--|
|  | <p><b>ELECTROCUTION HAZARD.</b></p> <p><b>When the disconnect switch is off, there is still live power within the disconnect switch's enclosure. Always turn off power at the building's power source to the equipment before opening this electrical enclosure!</b></p> |

3. Attach a lock and tag that meet OSHA requirements for lockout/tagout.
4. Restrain or de-energize all pneumatic components and other parts that could have live or stored power.

**Figure SAFETY-1: Lockout/Tagout on the Main Electrical Enclosure**

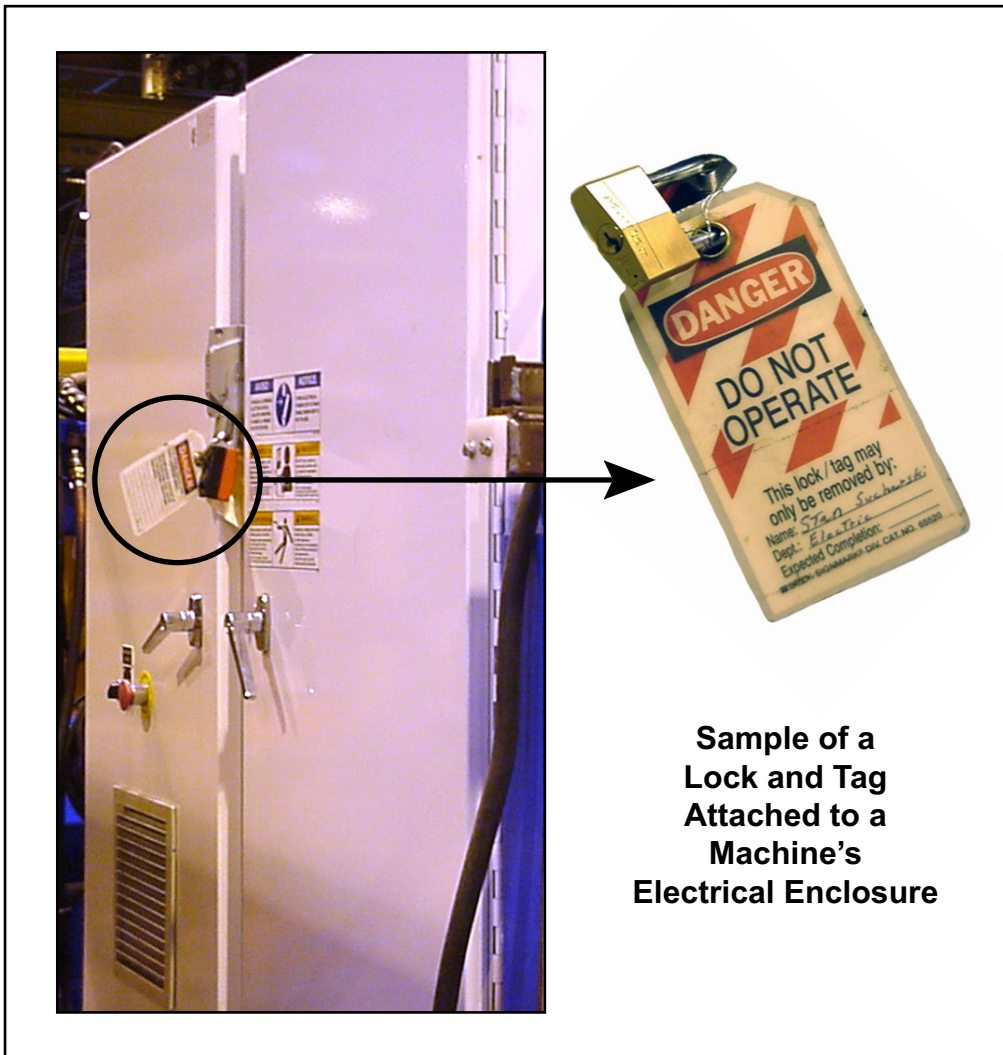

### **When Working on a Machine Inside the Machine's Main Electrical Enclosure or in the Electrical Transmission Line to the Machine**

Before opening the main electrical enclosure, or attempting to repair or replace an electrical transmission line to the machine, lockout/tagout the machine properly. Follow your company's approved lockout/tagout procedures which should include, but are not limited to the steps here.

1. Engage an E-stop on the machine.
2. Shut the power to the machine off at the machine's power source which is usually an electrical service entry panel on the facility wall. One example of a locked-out power source panel is shown in Figure SAFETY-2.
3. Attach a lock and tag that meets OSHA requirements for lockout/tagout.
4. Open the door to the main electrical enclosure, and using a multimeter, verify that the power is off.

**Figure SAFETY-2: Lockout/Tagout on the Power Source Panel**





## **Pneumatic System Lockout/Tagout Procedure**

### **When Lockout/Tagout is Not Required**

If working on components other than the pneumatic system, but that requires you to be near the vicinity of movable pneumatic components, you must, at a minimum, physically restrain the pneumatic components from moving. If this is not possible, lockout/tagout the entire pneumatic system.

### **When Lockout/Tagout is Required**

Before attempting repair or maintenance on a pneumatic line or component, lockout/tagout the machine properly. Follow your company's approved lockout/tagout procedures which should include, but are not limited to the steps here.

1. Follow instructions in the electrical and hydraulic lockout/tagout sections to lockout/tagout or prevent movement of these components.
2. Attach a lock and tag that meet OSHA requirements for lockout/tagout to the air regulator.
3. Bleed all pressure from the reservoir.
4. Bleed all pressure from all pneumatic lines by actuating all pneumatic valves associated with that air source

## **Troubleshooting With an Energized Machine**

Only a qualified electrician, using the personal protective equipment and following the procedures recommended in NFPA 70E should ever attempt service or repair of or near an energized area or component of the machine.

Whenever maintenance is performed while the equipment is electrically energized, there is a potential electric arc flash hazard. Refer to NFPA 70E for the personal protective equipment required when working with electrically energized components. Pneumatic and hydraulic components may move unexpectedly if not de-energized. Physically restrain any components capable of movement when working on or near those components.

## Restricted Zone

| <b>DANGER</b>   |  |
|---|--|
|  | <p>Stay out of the restricted zone when equipment is in use. Serious injury or death may result if personnel are in the restricted zone.</p> |

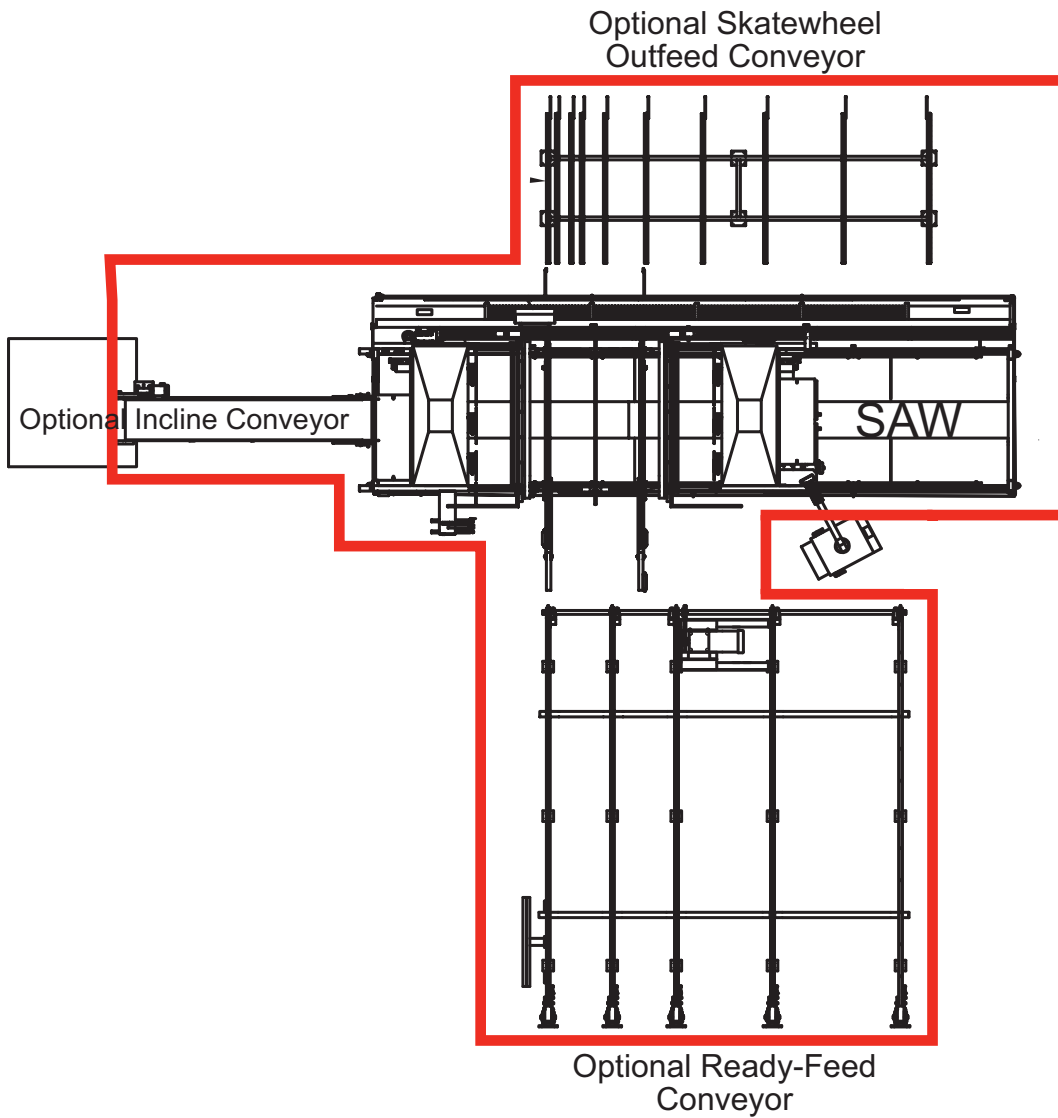

**DANGER**



Stay out of the restricted zone when equipment is in use. Serious injury or death may result if personnel are in the restricted zone.

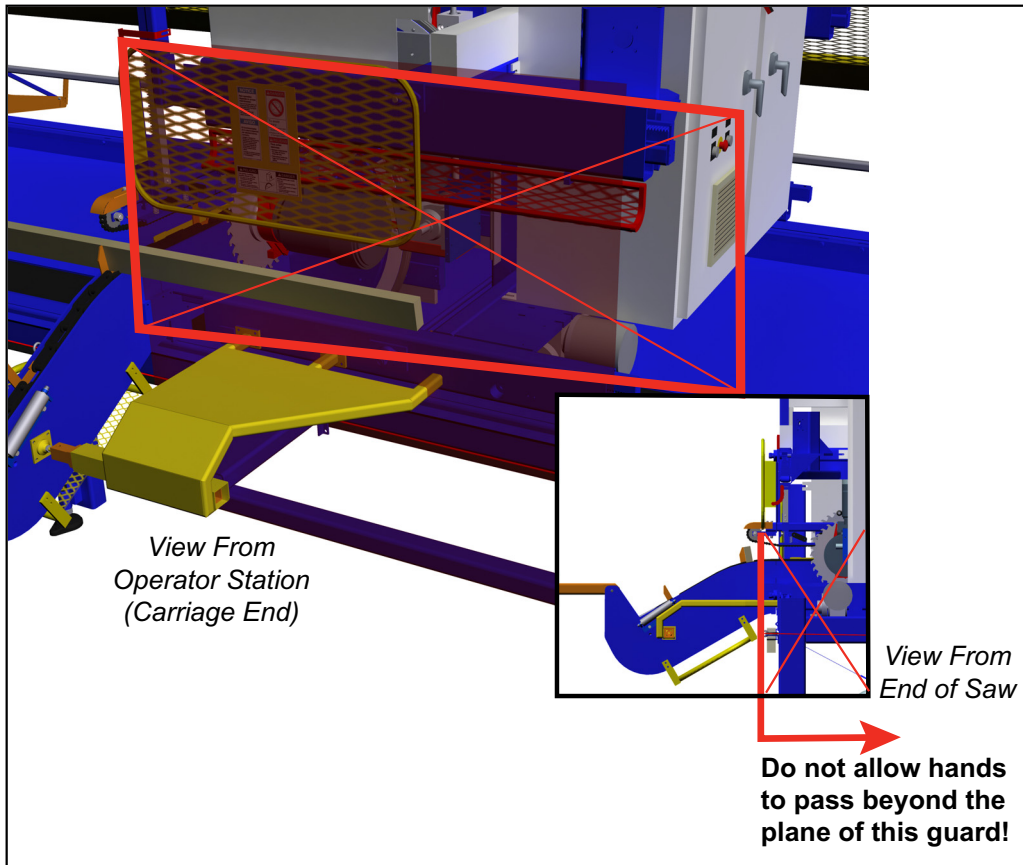

## Safety Test

| <b>DANGER</b>   |   |
|---|---|
|  | <p><b>CRUSH HAZARD.</b></p> <p>Perform the safety tests described before operating the equipment at the initial startup, after performing any maintenance, and in accordance with the maintenance schedule.</p> <p>Failure to perform these tests could result in severe injury or death.</p> |

Perform these safety tests daily before operating the saw and after performing any maintenance.

### Testing Emergency Stops (E-Stops)

Test that all E-stops are operating correctly at the beginning of each shift. To do so:

1. Start the blades using any operating mode.
2. Activate one E-stop.
  - a) Ensure that all movement stops within 6 seconds. If not, refer to page MT-163 in the *Troubleshooting* appendix to correct the problem and repeat the test.
  - b) The E-stop icon in the alarm bar at the top of the screen should blink in red.  
*If it did not blink, there is a problem with the saw controls or E-stop circuit wiring.*
  - c) Try to start one of the saw blades by pressing and holding one of the start buttons.  
*If the blade starts, there is a problem with the saw controls or E-stop circuit wiring.*
  - d) Clear the E-stop.
  - e) The emergency stop icon in the alarm bar at the top of the screen should stop blinking.
3. Repeat until all E-stops have been checked and passed the test.

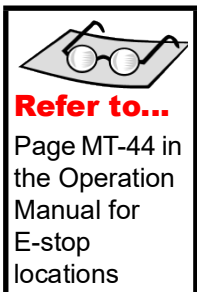

## Checking Saw Blades

| <b>DANGER</b>   |   |
|---|---|
|  | <p><b>ELECTROCUTION, HIGH PRESSURE, CRUSH, AND CUT HAZARDS!</b></p> <p>De-energize electrical and hydraulic power using approved lockout/tagout procedures on the power and air supplies before climbing into the saw. Failure to properly lockout/tagout this saw and remove the air supply may allow a blade to move causing severe personal injury or death.</p> |

| <b>WARNING</b>  |  |
|---|--|
|  | <p><b>CUT HAZARD.</b></p> <p>Saw blades are sharp and can cause severe cuts when being handled during installation and removal. Always wear gloves designed for use with sharp objects when handling the blades.</p> |

1. Check the condition of all saw blades.



- a) Rotate the blade in the cutting direction (toward the operator side). The blade should spin freely without touching the brake and have no indication of wobble. Refer to page MT-160 in the *Troubleshooting* appendix to correct a wobble.
- b) Check for the following items on a daily basis, and replace, repair, or re-tip the blades if any of the following characteristics are found.
  - Chipped or missing teeth or dull edges
  - Pitch build-up
  - Bending or warping of the blade or cracks in the blade plate (look carefully around the teeth and screw holes for cracks)

2. Test the saw blade brakes:

- a) To do so, start all saw blades, using any operating mode
- b) Press an E-stop or the stop sign on the touch screen.
- c) Using a stop watch, measure the time from the moment the stop button is pushed until all saw blades are completely still.



stop watch

The smaller blades will stop more quickly than the larger blades. All blades must stop within 6 seconds. If they do not, refer to page MT-163 in the *Troubleshooting* appendix.

### Inspecting the Saw



- 1. While standing in the saw waste conveyor, and with all power still locked and tagged out, visually check for cables that may interfere with movement of the blades, conveyors, or carriage. Secure cables as necessary.
- 2. Check that all guards are in place and secure.
  - a) Check the stationary and movable hold-down guards.
  - b) Check the lumber stop guard.
  - c) Check the left and right feed guards.
  - d) Check the stationary and movable operator guards.
  - e) Check the rear supports.

| <b>DANGER</b>   |   |
|---|---|
|  | <p><b>ELECTROCUTION, HIGH PRESSURE, CRUSH, AND CUT HAZARDS!</b></p> <p>Failure to operate the saw with all safety devices in proper working order and all safety guards in place may result in severe personal injury or death.</p> |

- 3. When all safety tests are completed and passed satisfactorily, restore air and electrical power to the saw.

# **Seguridad (Español)**

**Sea cuidadoso.  
Protéjase.**



## Indicadores de seguridad

Los siguientes símbolos de alerta de seguridad y palabras de advertencia se utilizan a lo largo de este documento para indicar riesgos de seguridad. Preste suma atención cuando los vea. Cada símbolo o palabra indica un nivel de gravedad diferente.

El no cumplimiento de las instrucciones que acompañan a cada símbolo de alerta de seguridad puede producir daños a la propiedad, lesiones personales e incluso la muerte. El personal debe seguir todos los procedimientos y prácticas de seguridad establecidos para asegurar el uso más seguro posible de este equipo. No obstante, en ningún caso este documento reemplaza el sentido común. El personal debe asegurarse de que el entorno de trabajo sea seguro y esté libre de distracciones.



### **PELIGRO**

Indica una situación de riesgo inminente que, si no se evita, pudiera producir la muerte o lesiones graves.



### **ADVERTENCIA**

Indica una situación potencialmente peligrosa que, si no se evita, puede producir la muerte o lesiones graves.



### **PRECAUCIÓN**

Cuando la PRECAUCIÓN se utiliza **con** el símbolo de alerta de seguridad aquí ilustrado, indica una situación potencialmente peligrosa que, si no se evita, puede producir lesiones menores o moderadas.

Cuando PRECAUCIÓN se utiliza **sin** el símbolo de alerta de seguridad aquí ilustrado, indica una situación potencialmente peligrosa que podría producir daños al equipo.

### **AVISO**

### **AVISO**

Llama la atención a información importante para entender la operación que se desea realizar.

### **AMBIENTAL**

### **AMBIENTAL**

Se aplica a condiciones que pueden afectar el entorno pero que no tienen un efecto inmediato o directo sobre el personal o el equipo.



## Reglas de seguridad

Debido a la imposibilidad de anticipar todas las circunstancias que podrían constituir un riesgo, la información de seguridad suministrada en este manual del equipo y sobre la máquina no es exhaustiva. Si se utiliza o realiza el mantenimiento de esta máquina utilizando un procedimiento no recomendado específicamente por el fabricante, el procedimiento deberá ser aprobado por un ingeniero profesional para asegurarse de que no afecte la seguridad del equipo. ¡Manéjese! siempre con suma precaución y sentido común!

### Conozca su equipo

- Lea este manual en su totalidad antes de utilizar o mantener el equipo. No utilice esta máquina a menos que esté perfectamente familiarizado con los controles, los dispositivos de seguridad, los frenos de emergencia y los procedimientos operativos que se describen en este manual.
- Lea y siga todas las notas de seguridad. El no cumplimiento de estas instrucciones podría producir pérdidas económicas, daños a la propiedad y lesiones personales, incluida la muerte.
- Refiérase a las pautas de bloqueo/etiquetado proporcionadas en las siguientes páginas para realizar el mantenimiento y solucionar problemas de este equipo en forma segura.
- Observe y cumpla con todas las etiquetas de seguridad. Cambie las etiquetas gastadas inmediatamente.
- Utilice este equipo únicamente para el propósito que se describe en este manual.
- Sólo personal calificado debe intentar utilizar o realizar el mantenimiento de este equipo. Por "personal calificado" se entiende:

*...una persona o personas que, por el hecho de poseer un título o certificado de capacitación profesional reconocido o que, por sus amplios conocimientos o experiencia, han demostrado con éxito estar capacitados para resolver problemas relacionados con el tema y el trabajo en cuestión—ANSI B30.2-1983*

*...una persona que posee habilidades y conocimientos relacionados con la construcción y uso de equipos e instalaciones eléctricas y que ha recibido capacitación en seguridad sobre los riesgos posibles—NEC 2002 Handbook*

### Seguridad personal

- Use siempre anteojos de seguridad y protección auditiva en un entorno industrial.
- Utilice una máscara protectora cuando trabaje cerca de aserrín.
- Utilice ropa adecuada y equipo de protección personal apropiado (por ejemplo, anteojos de seguridad y protección auditiva.) No use ropa suelta ni joyas. Si tiene el cabello largo, áteselo para atrás.
- Proceda con precaución cuando levante piezas o materiales pesados.

## **Instalación del equipo**

- Siga las instrucciones de instalación al pie de la letra.

## **Procedimientos de Bloqueo/Etiquetado**

- Antes de realizar el mantenimiento de los sistemas neumáticos o hidráulicos, purgue las líneas para eliminar la presión.
- Bloquee y etiquete todos los sistemas energizados antes de realizar tareas de mantenimiento en ellos. Refiérase a la sección *Pautas de bloqueo/etiquetado* en la página 20.

## **Cómo mantener un entorno seguro**

- Mantenga alejados a los niños. Todos los visitantes deben mantenerse a una distancia segura del área de trabajo. Los riesgos pueden no ser evidentes a las personas no familiarizadas con la máquina.
- Mantenga las áreas de trabajo bien iluminadas.
- Mantenga el área de trabajo limpia y libre de cualquier riesgo de tropiezo o resbalamiento.
- No utilice el equipo en lugares húmedos o mojados y no lo exponga a la lluvia o a la nieve.

## **Uso y mantenimiento del equipo**

- Asegúrese de que no haya personas, herramientas y objetos extraños en las zonas restringidas antes de utilizar este equipo. Las zonas restringidas se indican en la página 26.
- Realice las pruebas de seguridad recomendadas en la sección Prueba de seguridad en la página 28 antes de utilizar el equipo por primera vez, después de cualquier tarea de mantenimiento y conforme a la frecuencia de mantenimiento establecida.
- En caso de que la máquina no funcione correctamente, deténgala inmediatamente utilizando un freno de emergencia e informe el problema a un supervisor.
- No deje nunca la máquina encendida si no está junto a ella. ¡Apáguela!. No abandone la máquina hasta que todas las piezas se detengan completamente y hasta que se haya apagado la alimentación eléctrica.
- Verifique periódicamente que no haya piezas gastadas o dañadas. Repárelas o cámbielas inmediatamente.
- Mantenga los sistemas hidráulicos, neumáticos y eléctricos en buen funcionamiento en todo momento. Repare las fugas y las conexiones sueltas inmediatamente. No exceda nunca la presión ni potencia eléctrica recomendadas.
- Verifique que todos los dispositivos de seguridad estén en buen funcionamiento al comienzo de cada turno. Todos los dispositivos protectores y de seguridad deben

estar en su lugar antes y durante el uso de la máquina. No desconecte ni evite nunca ningún dispositivo de seguridad ni interbloqueo eléctrico.

- Inspeccione periódicamente la calidad del producto terminado.

### **Seguridad eléctrica**

- No utilice líquidos en el interior de los gabinetes eléctricos.
- Cuando utilice disolventes sobre o alrededor de la máquina, desconecte la alimentación para eliminar las probabilidades de chispas, que pueden producir una explosión o incendio. Use un respirador aprobado para el uso con disolventes. Use ropa protectora, guantes y anteojos de seguridad.

## Bloqueo/Etiquetado

### Pautas de bloqueo/etiquetado

**Deben cumplir con todas las pautas de bloqueo/etiquetado conforme a la norma OSHA 29 CFR 1910.147.** El programa de control de energía de la compañía debe incluir un procedimiento específico. El objetivo de este manual no es reemplazar el procedimiento de desenergización o bloqueo/etiquetado requerido por la OSHA, sino proporcionar pautas orientativas generales.

El término "bloqueo", según se utiliza en este manual, se refiere a la colocación de un dispositivo de bloqueo en las fuentes de energía para asegurar que el dispositivo aislador de energía y el equipo controlado por éste no puedan reenergizarse o utilizarse hasta que se retire dicho dispositivo.

Las fotos de la página siguiente muestran los lugares en los que se encuentran los interruptores de desconexión eléctrica de esta máquina.



- Las fuentes de energía incluyen energía eléctrica, mecánica, hidráulica, neumática, química, térmica y otras.
- En el caso de fuentes de energía eléctrica, la alimentación principal y la alimentación de control a la maquinaria deben apagarse y bloquearse físicamente en la posición "off" (apagado).
- Por lo general, como dispositivo de bloqueo se utiliza un candado con llave.
- Si hay más de una persona trabajando en una zona restringida, utilice un dispositivo de bloqueo grupal que permita a cada persona utilizar un candado que sólo pueda ser retirado por la persona que realiza el mantenimiento.

"Etiquetado" significa que debe colocarse una advertencia fácil de ver en un dispositivo aislador de energía que indique que el equipo no debe utilizarse.

## Procedimientos de bloqueo/etiquetado eléctricos

### Quando trabaja en una máquina fuera del gabinete eléctrico principal de la máquina



Si trabaja en la línea de transmisión eléctrica a la máquina, siga el procedimiento de la página 23.

Antes de realizar el mantenimiento de cualquier máquina con alimentación eléctrica, bloquee y etiquete la máquina de forma adecuada. Cuando trabaje en una máquina fuera del gabinete eléctrico principal de la máquina, salvo en el caso de trabajos en la línea de transmisión eléctrica a la máquina, siga los procedimientos de bloqueo/etiquetado aprobados por la compañía, los cuales deberían incluir, entre otros, los pasos aquí indicados.

1. Coloque un freno de emergencia sobre la máquina.
2. Coloque el mango del interruptor con fusibles del gabinete eléctrico principal de la máquina en la posición "apagado/apagada". Vea la figura 2-1.

| <b>WARNING</b>  |  |
|---|--|
|  | <b>RIESGO DE ELECTROCUCIÓN.</b><br><b>Quando el interruptor con fusibles está apagado, sigue habiendo energía dentro del gabinete del interruptor. ¡Apague siempre la alimentación en la fuente de alimentación del edificio antes de abrir este gabinete eléctrico!</b> |

3. Coloque un candado y una etiqueta que cumplan con los requisitos de bloqueo/etiquetado de la OSHA.
4. Trabe o desenergice todos los componente neumáticos y otras piezas que tengan alimentación directa o almacenada.

Figure SAFETY-1: Bloqueo/etiquetado en el gabinete eléctrico principal

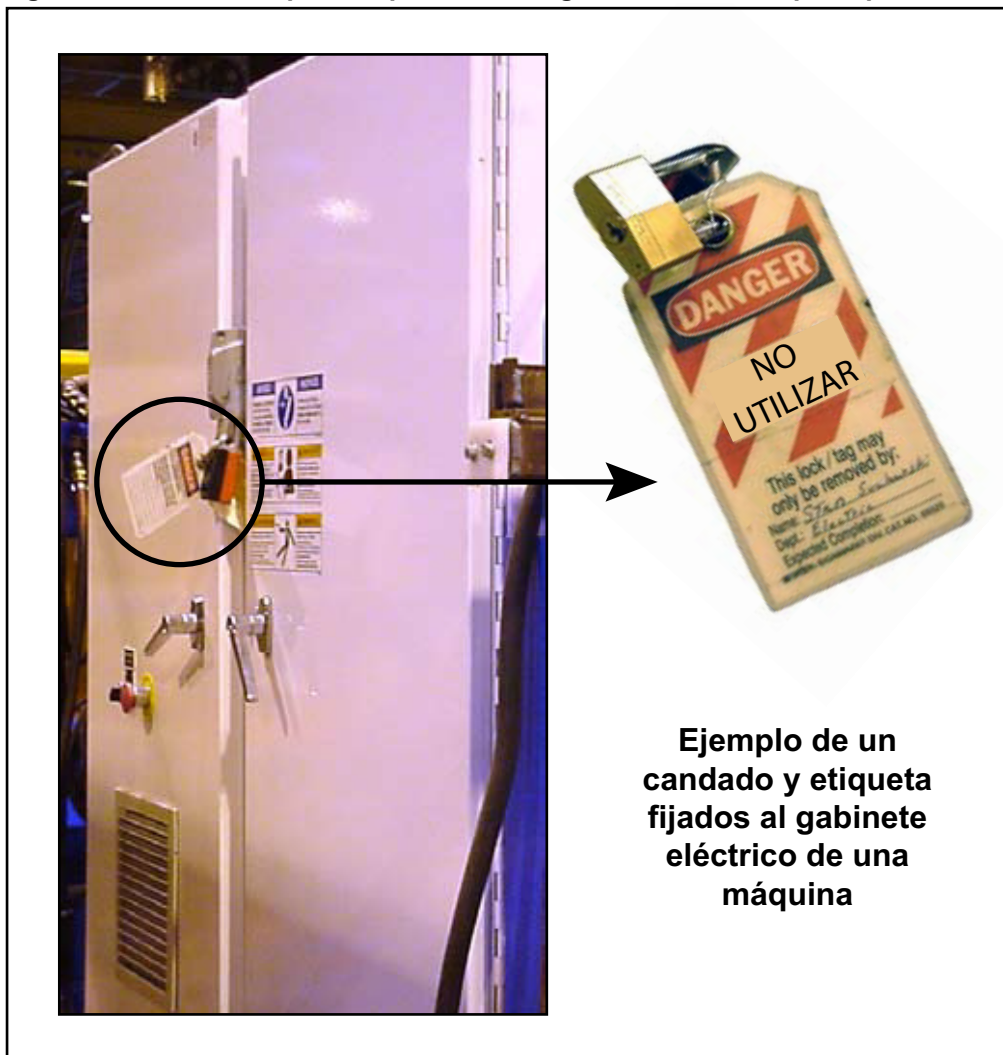

### **Cuando trabaje en una máquina dentro del gabinete eléctrico principal de la máquina o en la línea de transmisión eléctrica a la máquina**

Antes de abrir el gabinete eléctrico principal o intentar reparar o reemplazar una línea de transmisión eléctrica a la máquina, bloquee y etiqueta la máquina en forma adecuada. Siga los procedimientos de bloqueo/etiquetado aprobados por la compañía, los cuales deberían incluir, entre otros, los pasos aquí indicados.

1. Coloque un freno de emergencia sobre la máquina.
2. Apague la alimentación a la máquina en la fuente de alimentación, que, por lo general, es un panel de entrada de suministro eléctrico que se encuentra en una pared de las instalaciones. En la figura 2-2 se muestra un ejemplo de panel de fuente de alimentación bloqueado.
3. Coloque un candado y una etiqueta que cumplan con los requisitos de bloqueo/etiquetado de la OSHA.
4. Abra la puerta del gabinete eléctrico principal al que necesita acceder y usando un multímetro verifique que la alimentación esté apagada.

**Figure SAFETY-2: Bloqueo/Etiquetado del panel de fuente de alimentación**



## **Procedimiento de bloqueo/etiquetado del sistema neumático**

### **Cuando no se requiere bloqueo/etiquetado**

Si trabaja con componentes que no son del sistema neumático pero que requieren su presencia en la proximidad de componentes neumáticos móviles, debe, como mínimo, trabar físicamente estos componentes para que no se muevan. Si no es posible, bloquee/etiquete todo el sistema neumático.

### **Cuando se requiere bloqueo/etiquetado**

Antes de intentar reparar o realizar el mantenimiento de una línea o componente neumático, bloquee/etiquete la máquina en forma apropiada. Siga los procedimientos de bloqueo/etiquetado aprobados por la compañía, los cuales deberían incluir, entre otros, los pasos aquí indicados.

1. Siga las instrucciones de las secciones de bloqueo/etiquetado eléctrico y neumático para bloquear y etiquetar o evitar el movimiento de estos componentes.
2. Coloque un candado y una etiqueta que cumplan con los requisitos de bloqueo/etiquetado de la OSHA en el regulador de aire.
3. Purgue toda la presión del reservorio.
4. Purgue la presión de todas las líneas neumáticas activando las válvulas neumáticas asociadas con dicha fuente de aire.



## **Solución de problemas con una máquina energizada**

Sólo un electricista calificado que utilice el equipo de protección personal y siga los procedimientos recomendados en la norma NFPA 70E debe intentar realizar tareas de reparación o mantenimiento en un área o componente energizados de la máquina o en su proximidad.

Cada vez que se realizan tareas de mantenimiento mientras el equipo está eléctricamente energizado, existe un riesgo potencial de formación de un arco eléctrico. Consulte en la norma NFPA 70E el equipo de protección personal requerido para trabajar con componentes eléctricamente energizados. Los componentes neumáticos e hidráulicos pueden moverse de manera imprevista si no se desenergizan. Trabe físicamente cualquier componente que pueda moverse cuando deba trabajar en ellos o en su proximidad.

## Zonas restringida

| <b>DANGER</b>   |   |
|---|---|
|  | <p>Manténgase afuera de la zona restringida cuando el equipo esté en uso. Pueden producirse lesiones graves o incluso la muerte si el personal está en la zona restringida.</p> |

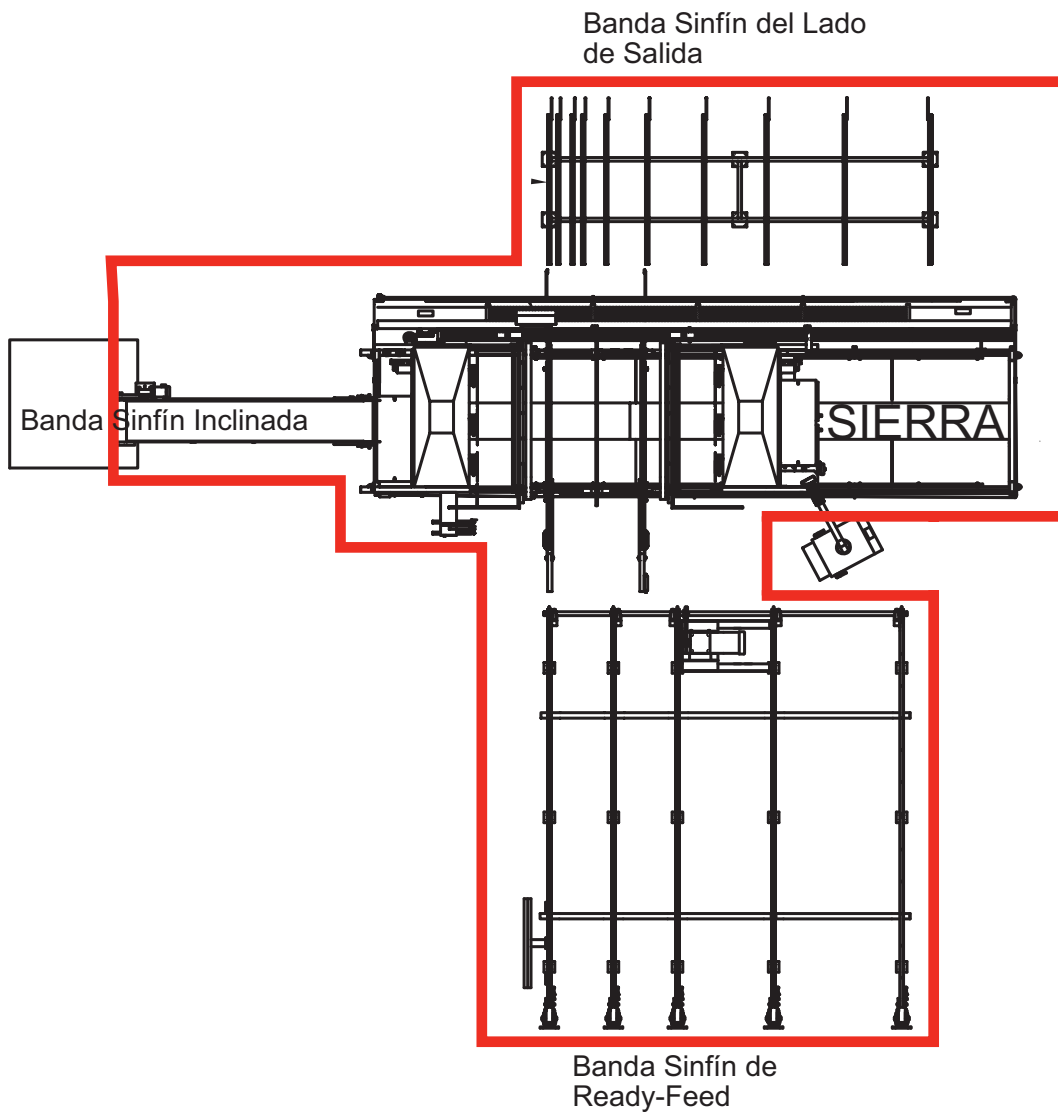

| <b>DANGER</b>   |   |
|---|---|
|  | <p>Manténgase afuera de la zona restringida cuando el equipo esté en uso. Pueden producirse lesiones graves o incluso la muerte si el personal está en la zona restringida.</p> |

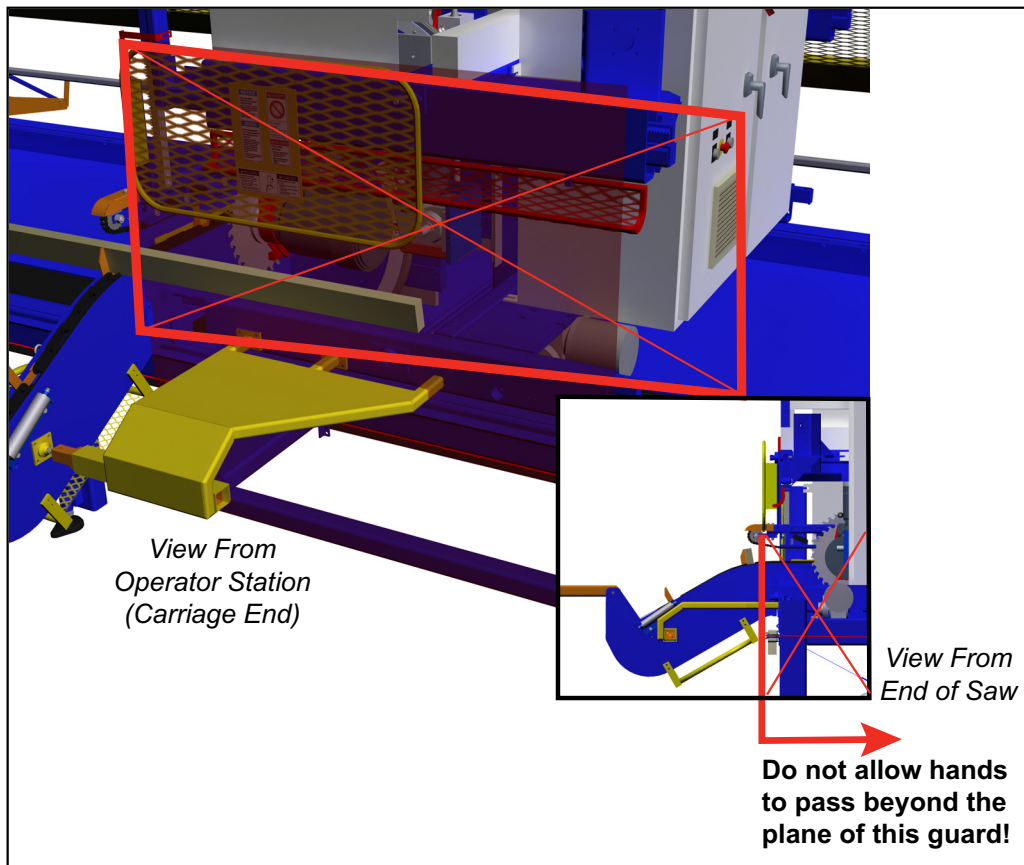

## Prueba de seguridad

| <b>DANGER</b>   |   |
|---|---|
|  | <p><b>RIESGO DE APLASTAMIENTO.</b></p> <p>Realice las pruebas de seguridad que se describen antes de utilizar el equipo por primera vez, después de cualquier tarea de mantenimiento y conforme con la frecuencia de mantenimiento establecida. Si no se realizan estas pruebas, pueden producirse lesiones graves e incluso la muerte.</p> |

Realice estas pruebas de seguridad a diario antes de utilizar la sierra y después de cualquier tarea de mantenimiento.

### ***Prueba de frenos de emergencia***

Verifique que todos los frenos de emergencia estén funcionando correctamente al comienzo de cada turno. Para ello, proceda como se indica a continuación:

1. Ponga en marcha las hojas en cualquier modo de funcionamiento.
2. Active un freno de emergencia.
  - a) Asegúrese de que las hojas se detengan completamente dentro de los 6 segundos. Si esto no ocurre, refiérase a la página MT-136 del apéndice de *Solución de problemas* para remediar el problema y repita la prueba.
  - b) El icono de freno de emergencia en la barra de alarma en la parte superior de la pantalla debería parpadear de color rojo.
 

*Si no parpadea, hay un problema con los controles de la sierra o con las conexiones del circuito del freno de emergencia.*
  - c) Intente poner en marcha una de las hojas de la sierra presionando y manteniendo presionado uno de los botones de arranque.
 

*Si la hoja se pone en marcha, hay un problema con los controles de la sierra o con las conexiones del circuito del freno de emergencia.*
  - d) Desconecte el freno de emergencia.
  - e) El icono de freno de emergencia en la barra de alarma en la parte superior de la pantalla debería dejar de parpadear.
3. Repita el procedimiento hasta que todos los frenos de emergencia hayan sido verificados y pasen la prueba.

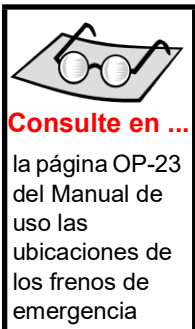

## Verificación de las hojas de la sierra

| <b>DANGER</b>   |  |
|---|--|
|  | <p><b>¡RIESGO DE ELECTROCUCIÓN, ALTA PRESIÓN, APLASTAMIENTO Y CORTE!</b></p> <p>Desconecte la energía eléctrica e hidráulica utilizando procedimientos de bloqueo/etiquetado aprobados en el suministro de alimentación y aire antes de subirse a la sierra. Si no bloquea/etiqueta la sierra y elimina el suministro de aire, la sierra podría moverse y causar lesiones personales graves e incluso la muerte.</p> |

| <b>WARNING</b>  |  |
|---|--|
|  | <p><b>RIESGO DE CORTE.</b></p> <p>Las hojas de la sierra son afiladas y pueden producir cortes graves cuando están siendo manejadas durante la instalación y la eliminación. Use siempre guantes diseñados para trabajar con objetos afilados cuando manipule las hojas.</p> |

1. Verifique el estado de todas las hojas de la sierra.
  - a) Haga girar la hoja en la dirección de corte (hacia el lado del operador). La hoja debería girar libremente sin tocar el freno y sin tambalearse. Si tambalea, refiérase a la página MT-133 del apéndice de *Solución de problemas* para remediar el problema.
  - b) Verifique lo siguiente a diario y cambie, repare o afile las hojas si encuentra cualquiera de las características enumeradas a continuación.
    - Dientes muescados o faltantes o bordes desafilados
    - Acumulación de brea
    - Doblado o pandeado de la hoja o grietas en la placa de la hoja (mire con atención alrededor de los dientes y los orificios de los tornillos para asegurarse de que no haya grietas)

2. Pruebe los frenos de la hoja de la sierra:

- a) Para ello, ponga en marcha todas las hojas en cualquier modo de funcionamiento.
- b) Presione un freno de emergencia o el signo STOP (ALTO) en la pantalla táctil.
- c) Con un cronómetro, mida el tiempo transcurrido desde el momento en que presiona el botón STOP (ALTO) hasta que todas las hojas de la sierra se hayan detenido completamente.



cronómetro

Las hojas más pequeñas se detendrán con más rapidez que las más grandes. Todas las hojas deben detenerse dentro de los 6 segundos. Si esto no ocurre, refiérase a la página MT-136 del apéndice de *Solución de problemas*.

## Inspección de la sierra



- 1. Mientras está de pie en la banda transportadora de desperdicios, y con toda la alimentación aún bloqueada y etiquetada, inspeccione visualmente que no haya cables que interfieran con el movimiento de las hojas, las bandas transportadoras o el carro. Fije los cables cuando sea necesario.
- 2. Verifique que todos los protectores estén en su lugar y bien fijados.
  - a) Verifique los protectores sujetadores fijos y móviles.
  - b) Verifique el protector de tope de la madera.
  - c) Verifique los protectores de alimentación izquierdo y derecho.
  - d) Verifique los protectores fijos y móviles del operario.
  - e) Verifique los soportes traseros

| <b>DANGER</b>   |   |
|---|---|
|  | <p><b>¡RIESGO DE ELECTROCUCIÓN, ALTA PRESIÓN, APLASTAMIENTO Y CORTE!</b></p> <p><b>Si la sierra no se utiliza con todos los dispositivos de seguridad en perfecto estado de funcionamiento y con todos los protectores de seguridad en su lugar, pueden producirse lesiones personales, incluida la muerte.</b></p> |

- 3. Una vez realizadas todas las pruebas de seguridad y una vez que hayan sido aprobadas en forma satisfactoria, restaure la alimentación de aire y eléctrica a la sierra.

### Purpose of Chapter

This chapter explains how to navigate through the entire equipment manual and how to contact MiTek.

## Introduction to the Equipment Manual

| <b>DANGER</b>  |   |
|--|---|
|  | <p><b>Read this manual completely before using this equipment!</b></p> <p><b>Do not operate this machine until you have a thorough understanding of all controls, safety devices, emergency stops, and operating procedures outlined in this manual.</b></p> <p><b>All warnings must be read and observed. Failure to do so may result in economic loss, property damage, and/or personal injury.</b></p> <p><b>This manual must always be available to personnel operating and maintaining this equipment.</b></p> |

### Purpose and Scope of This Equipment Manual





This equipment manual (set of three books) provides the information necessary to operate and maintain this equipment. In order for this equipment manual to be useful, it must be easily accessible to the operators and maintenance personnel. Review the table of contents to understand the structure of the chapters. The appendices, indices, and glossary are also valuable tools for getting the most out of your equipment. They are located at the back of the Maintenance Manual.

This equipment manual addresses the current versions of the *MiTek® Cyber® A/T* saw although some major features and components on previous versions of the saw are addressed to clarify certain items.

## Graphics Used to Help Navigate

The graphics in Table 1-1 are used throughout the manual to quickly communicate a specific type of information.

**Table 1-1: Navigational Tools Used Throughout the Manual**

| Graphic   | Explanation  |
|---|--|
|    | <p>Important safety note!</p> <p>Indicates that you must lockout/tagout the equipment using approved methods described in OSHA 29 CFR 1910.147 before continuing with the procedure.</p> |
|    | <p>Indicates tools required before beginning a procedure.</p>  |
|    | <p>Gives additional information to the steps or text.</p>  |
|   | <p>Indicates how to get to or from the item discussed.</p>   |
|  | <p>Refers reader to another section, table, graphic, or drawing for further explanation.</p>   |



## Using This Manual

### The Equipment Manual Set

All of the information you need to install, operate, and maintain your equipment is contained in a three-manual set as described in Table 1-2. Each of the three manuals has its own table of contents and index. The appendices and a glossary for the entire manual set are located at the back of the Maintenance Manual.

**Table 1-2: Manual Set 001055**

| Manual Title                     | Page # Prefix | Description  | Part #    |
|----------------------------------|---------------|--|-----------|
| Book 1<br>Operation<br>Manual    | OP            | Includes operation procedures and defines the control user interface   | 001055-OP |
| Book 2<br>Maintenance<br>Manual  | MT            | Includes preventive maintenance, repair maintenance, troubleshooting, parts list, drawing set list, and glossary | 001055-MA |
| Book 3<br>Installation<br>Manual | IN            | Includes requirements prior to installation, installation procedures, and startup procedures.                    | 001055-IN |

### The Drawing Set

The drawing set is part number 001069. A list of the drawings can be found in the Maintenance Manual, but the actual drawings are in a separate 11x17 binder. The binder may be labeled 001055, like the manuals, or it may have a separate part number, 0014069. Both of these part numbers apply to the *Cyber A/T* saw made at the time of the purchase.

### Formatting Cues

To follow the procedures in this manual, you must first understand the formatting cues used. Table 1-3 describes how to read the cues provided in this text.

**Table 1-3: How to Read the Formatting Cues**

| If Text Looks Like...        | It Indicates...  | Example in Text               |
|------------------------------|--|-------------------------------|
| All caps                     | Key on keyboard or button on screen                          | Press ENTER                   |
| Initial cap and italics      | Menu or field or virtual button that you must find or select | Click on the <i>File</i> menu |
| Initial cap only, no italics | Menu or field or virtual button when simply referring to it  | While in the Main Menu        |
| Plus sign (+)                | Hold buttons at the same time                                | CTRL+ALT+DELETE               |
| Greater Than sign (>)        | Next selection   | <i>File&gt;Open</i>           |

## Screen Shots

Most screen shots are from *Cimplicity*<sup>®</sup> Project version 20.11. Screens from other Project versions may differ slightly.

## Contacting MiTek

For technical assistance or to order parts, contact the Machinery Division Customer Service Department using one of the methods listed in Figure 1-1.

**Figure 1-1: Contacting MiTek**

|   |   |
|---|---|
| <p><b>MiTek Machinery Division</b><br/>Customer Service Department<br/>301 Fountain Lakes Industrial Drive<br/>St. Charles, MO 63301</p> <p><b>Parts Orders (with part number)</b><br/>E-mail: <a href="mailto:mitekparts@mii.com">mitekparts@mii.com</a></p> <p><b>Technical Assistance</b><br/>Phone: 800-523-3380<br/>Fax: 636-328-9218<br/><a href="mailto:machinerysupport@mii.com">machinerysupport@mii.com</a></p> <p><b>Web Site</b><br/><a href="http://www.mitek-us.com">www.mitek-us.com</a></p> |  The MiTek logo, consisting of the letters 'MII' in a bold, black, sans-serif font with three horizontal blue lines through the 'I', positioned to the right of the contact information. |
|---|---|

### Purpose of Chapter

This chapter provides an overview of your equipment and the means to identify it.

## Introduction to the Equipment

### Purpose of the Equipment

The *Cyber A/T* saw is a fast, accurate, and economical method of cutting a wide array of components for wood truss manufacturing. It is capable of cutting lumber for all of your roof and floor truss needs, within certain specifications.

### Description of the Equipment

The *Cyber A/T* saw is a self-contained wood-cutting machine consisting of up to six (6) blades located in two sets of three (3) blades each. One set is considered the “stationary end.” The second set, considered the “carriage end,” moves for different lumber lengths.

Each blade assembly is considered a quadrant. Each quadrant is capable of tilting and elevating to cut lumber to specific angles. Saws can be shipped with any combination of blades, and arrangements of fewer than six (6) blades can exist to fit each customer’s needs.

Figure 2-1 shows a saw. Refer to the Maintenance Manual for more detailed graphics.

**Figure 2-1: Cyber A/T Saw**

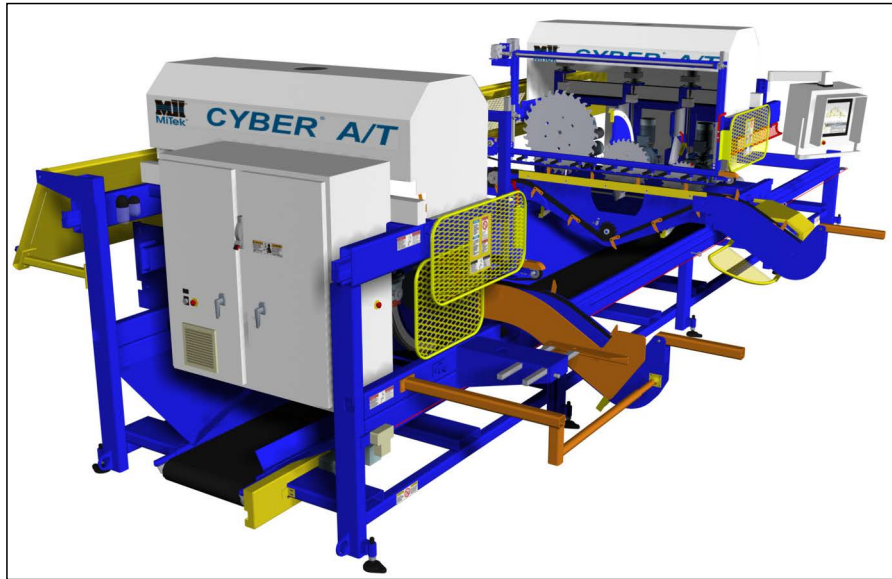

## Features

- Individually powered centerline and angulation adjustment for each saw blade
- Powered carriage travel
- Powered horizontal and vertical hold-down adjustment with scale
- Pneumatic lateral adjustment for in- and out-of-cut on blades 5 and 6
- Powered vertical adjustment for in- and out-of-cut on blades 1, 2, 3, and 4
- Pneumatic brakes on saw blades and carriage
- Powered 24-in.-wide full-length waste conveyor
- Electronic lumber counter
- Heavy-duty 2120 infeed conveyor chains
- Fixed feed chain sprockets for synchronizing pushers
- Rack and pinion lumber stop with scale
- Adjustable lumber guide
- Center lumber support
- Heel cut skid bar
- Floor truss web riser bar

## Variations and Options

**Table 2-1: Available Models**

| Equipment Description | MiTek Part # |
|-----------------------|--------------|
| 30' saw               | 60000-530    |
| 34' saw               | 60000-534    |

**Table 2-2: Optional Components**

| Optional Component or Feature           | MiTek Part #   |
|---|--|
| Quad 6                                  | 60155-501  |
| 12' incline waste conveyor              | 7022100 (individual)   |
| Ready-Feed lumber conveyor (for infeed) | 70775-501-xxxV   |
| Outfeed skatewheel conveyor             | 75500-501  |
| Bridge conveyor                         | Call Customer Service for options  |
| Inker                                   | 78830-501 & 90483KIT-501 (factory install)<br>78830-502 & 90483KIT-601 (field install) |
| Catcher Display                         | 60122-501 (factory install)<br>60122KIT (field install)                                |
| Transformer                             | 509154   |
| Spare parts kit                         | 60000-901  |

## General Specifications

**Table 2-3: General Specifications for a Standard Cyber A/T Saw**

| <b>SAW BLADES</b>  |  |
|--|--|
| Blade 1  | 7 hp, 3450 rpm with 20" carbide-tipped blade                                     |
| Blade 2  | 7 hp, 3450 rpm with 16" carbide-tipped blade (optional 20" carbide tipped blade) |
| Blade 3  | 7 hp, 3450 rpm with 16" carbide-tipped blade (optional 20" carbide tipped blade) |
| Blade 4  | 7 hp, 3450 rpm with 20" carbide-tipped blade                                     |
| Blade 5  | 13 hp, 1725 rpm with 32" carbide-tipped blade                                    |
| <b>OVERALL DIMENSIONS</b>  |  |
| Length <b>without</b> incline waste conveyor                       | 32'  |
| Length <b>with</b> incline waste conveyor                          | 45'  |
| Width  | 15' 1"   |
| Height   | 9' 1"  |
| <b>CAPACITY</b>  |  |
| Max. lumber size for roof truss configuration                      | 2" x 12"   |
| Max. lumber size for floor truss configuration                     | 4" x 2"  |
| Max. straight cut length   | 20'  |
| Min. straight cut length   | 14"  |
| Min. cut with four 45 degree angles                                | 22"  |
| Max. scarf cut length with 32" blade                               | 29.5"  |
| Max. scarf cut length with 16" blade                               | 10.5"  |
| Max. scarf cut length with 20" blade                               | 16"  |
| <b>CALIBRATION ACCURACIES</b> (also listed in Calibration section) |  |
| Length specifications  | ± 1/16"  |
| Angle  | ± 1/10°  |
| Centerline   | ± 1/16"  |
| <b>ELECTRICAL INFORMATION</b>                                      |  |
| See Table 2-3 in the <i>Prior to Installation</i> chapter.         |  |
| <b>SAFETY FEATURES</b>   |  |
| Master operator shut-off control                                   |  |
| Perimeter mounted shutdown cable                                   |  |
| Fully shrouded protective guards and shields                       |  |
| <b>WEIGHT OF SYSTEM COMPONENTS</b>                                 |  |
| See Table 2-5 in the <i>Prior to Installation</i> chapter.         |  |

## Truss Terminology

Table 2-4: Truss Terminology

| Length Types      | Height Types |                   |
|-------------------|--------------|-------------------|
| Overall length    | H1           | Board height      |
| Centerline length | H2           | Centerline height |
| Top length        | H3           | Centerline height |
| Bottom length     | H4           | Centerline height |

Figure 2-2: Terminology Diagram

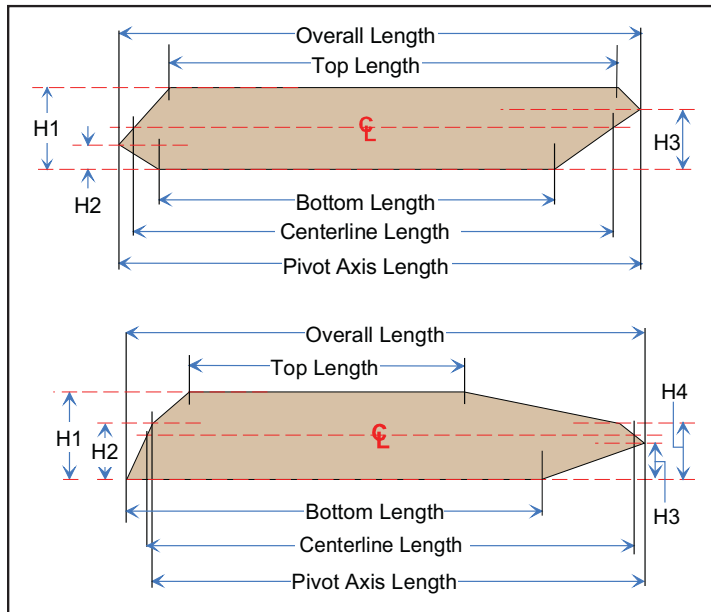
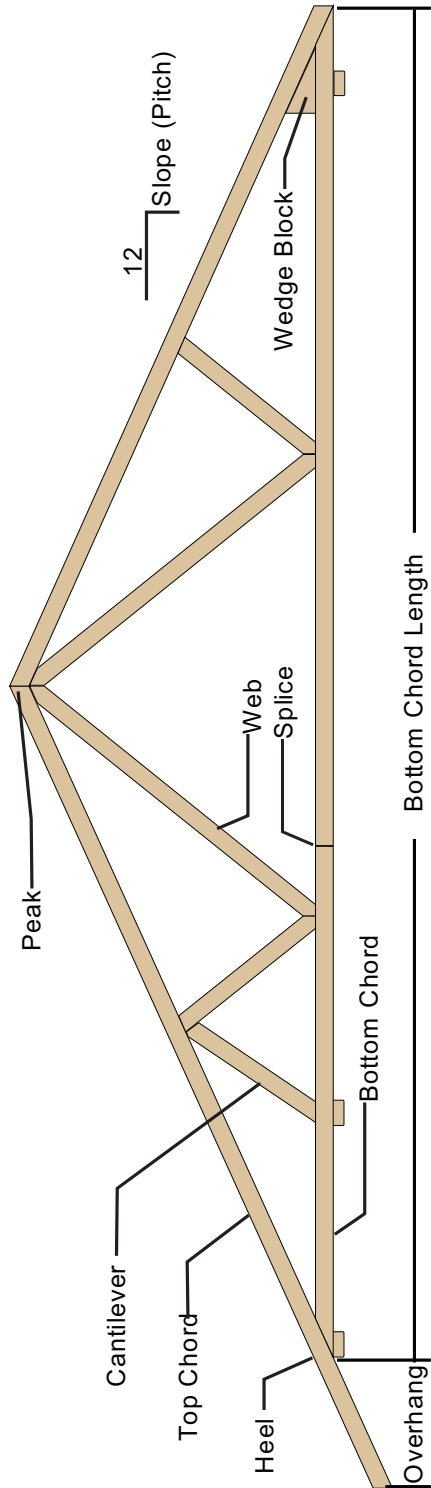



Figure 2-3: Parts of a Truss





### Purpose of Chapter

This chapter describes the operating mechanisms on this equipment and the procedure to operate it in most circumstances.

| <b>DANGER</b>  |   |
|--|---|
|  | <p><b>ELECTROCUTION, HIGH PRESSURE, CRUSH, CUT, AND CHEMICAL HAZARDS!</b></p> <p><b>Read this manual completely before using this equipment.</b></p> <p><b>Do not operate this machine until you have a thorough understanding of all controls, safety devices, emergency stops, and operating procedures outlined in this manual.</b></p> <p><b>All warnings must be read and observed. Failure to do so may result in economic loss, property damage, and/or personal injury.</b></p> <p><b>This manual must always be available to personnel operating and maintaining this equipment.</b></p> |

## Navigation

### Navigating the Operation Chapter

The chapter is broken down into sections as described in Table 3-1. Becoming familiar with the structure of the chapter will help you get the most out of your equipment.

**Table 3-1: Structure of Operation Chapter**

|  |             |
|--|-------------|
| Operation Part 1: Introduction to the Equipment    | page OP-43  |
| Operation Part 2: Operating Procedures             | page OP-48  |
| Operation Part 3: Software Screens                 | page OP-76  |
| Operation Part 4: Sample Cuts                      | page OP-111 |
| Operation Part 5: Angle and Slope Conversion Chart | page OP-121 |

## **Navigating Windows Software Without a Mouse**

### **To left-click (also called “select”)**

Using the keyboard, direct the cursor to the icon by using the arrow keys or TAB key. Press the ENTER key to select it. It may be necessary to press the space bar to highlight the icon before pressing ENTER.

### **To open the START menu**

Press CTRL-ESC or press the key that looks like a flying window.

### **To right-click**

Direct the cursor to the correct location by using the same procedure as used in the *To left-click (also called “select”)* section. View the right-click menu by pressing the SHIFT-F10 keys on the keyboard or pressing the key between the flying window key and the CTRL key.

### **To view a menu on the menu bar**

Press the ALT key along with the letter that is underlined in the menu name.

### **Opening *Windows Explorer***

Right-click the START menu

### **To navigate *Windows Explorer***

Press the TAB key to toggle between the two frames.

# Operation Part 1: Introduction to the Equipment

## Quad and Blade Numbers

Figure 3-1: Quad and Blade Numbers, Overhead View of Saw

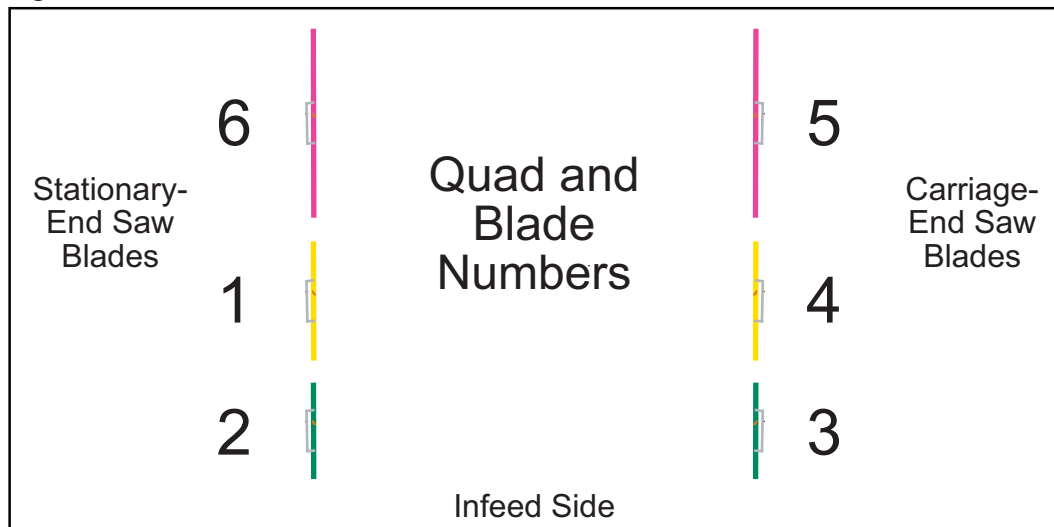

## Safety Test Requirements

Before operating the equipment on each work shift, test that all E-stops are working correctly and that saw blade brakes are functioning efficiently. Perform the procedure in the *Safety Test* section starting on page OP-12. See page OP-28 for the Spanish translation.

## Emergency Stopping Methods

Refer to the *Operation Part 2: Operating Procedures* section for normal powering up and shutting down of the equipment. This section describes how to quickly stop the saw for safety reasons. See Figure 3-2 on page OP-44 for E-stop locations.

## Overview of Emergency Stops (E-Stops)

Emergency stops (E-stops) cease control power immediately. The only control power existing in the machine after an E-stop is actuated is the power that energizes the maintenance lights. Utilize any of the E-stops on this machine to cease power, which will stop the blades and all motion.

Do not use the E-stops as a standard stopping method when cutting is complete. Overuse may cause certain components to wear faster.

Note the different types of E-stops and their locations shown in Figure 3-2.

Figure 3-2: Location of E-Stops

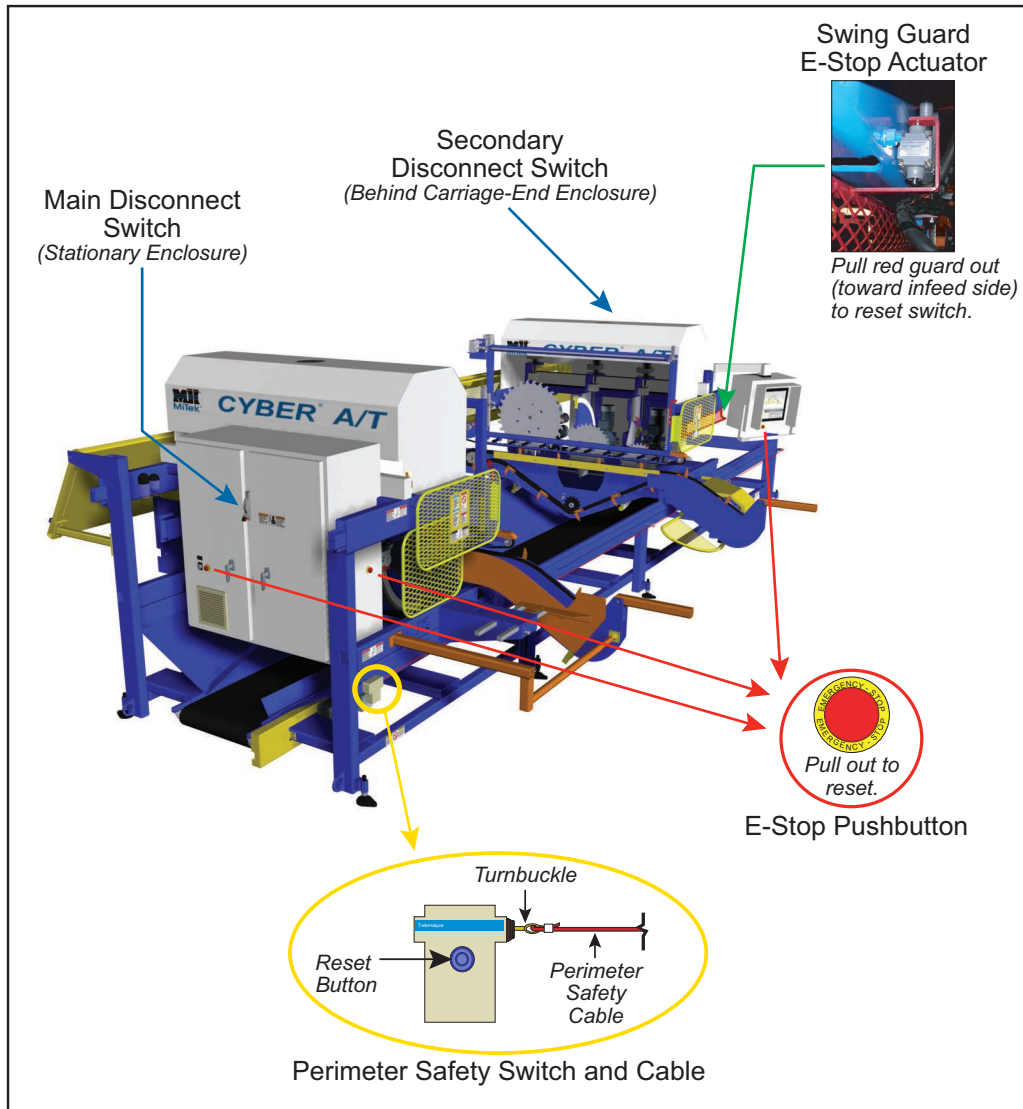

## E-Stop Pushbuttons

Push one of the red emergency stop (E-stop) pushbuttons to cease power transmitting to the control circuit. The pushbutton locations can be seen in Figure 3-2. A typical E-stop pushbutton is shown in Figure 3-3.

To release the E-stop, pull the pushbutton straight out. It will return to its extended position, and the machine will operate again.

Figure 3-3: E-Stop Pushbutton



## Perimeter Safety Cable (Pull-Cord)

Pull the perimeter safety cable away from the saw to cease power transmitting to the control circuit. The safety cable should have a maximum of 8 in. slack in either direction before it shuts off the saw.

There are two cable and switch box pairs. You must press the button on the correct switch box to reset the circuit after someone pulls a perimeter safety cable. See the *Maintaining the Perimeter Safety Cable* section for instructions on reconfiguring the switch to adjust the tension of the cable.

## Swing Guard E-Stop Actuator

The swing guard E-stop actuator is an expanded medal guard, but it is also an E-stop. Its purpose is to protect infeed operators by preventing them from reaching a saw blade while standing at the typical location an operator would stand. Figure 3-2 shows the location of the swing guard.

## Disconnect Switches

Turn both disconnect handles to the off position when the machine is not in use. See Figure 2-1 for the location of the main disconnect switch. The *Understanding the Disconnect Switches* section on page MT-37 explains the main disconnect switch and the secondary disconnect switch.



The saw will not operate without the proper air pressure connected to it.

## Tips for Using the Operator Control Interface

### Using the Touch Screen

- Use only your finger to press buttons on the touch screen. Hard objects can damage the touch functionality.
- Press the buttons on the touch screen so your finger rests completely on the button and pauses.
- It is recommended that a keyboard and mouse be available for use to supplement the touch screen. If you need to navigate around the *Windows* software without a mouse, see the tips on page OP-42.
- Always use overlays on the touch screen surface to protect it. Refer to the *Replacing the Touch Screen Overlays* section on page MT-115 for instructions on replacing the overlay.

#### CAUTION

An overlay must be kept on your touch screen at all times to protect the bezel and touch screen from excessive wear, scratching, and other damage. An overlay will greatly increase the life of your touch screen and help to maintain the quality of the image on-screen.

Figure 3-4: Touch Screen Monitor



## Getting Familiar With the Software

Several software programs are in use when operating the *Cyber A/T* saw. Table 3-2 outlines the software programs on every MiTek-supplied computer for a *Cyber A/T* saw, and Table 3-3 introduces you to optional software that will allow you to use the saw to its fullest potential.

**Table 3-2: Software Included With Every *Cyber A/T* Saw**

| Software                      | Description  | Interesting Notes   |
|-------------------------------|--|---|
| Operating system              | Program that allows all other programs to function   | Example: <i>Windows<sup>®</sup> XP</i>  |
| <i>Cimplicity<sup>®</sup></i> | Software that allows the personal computer and the PLC on the saw to communicate with each other | The <i>Cimplicity</i> software in use must be compatible with the Project and PLC software in use.  |
| Project                       | Subset of <i>Cimplicity</i> that executes specific saw functions                                 | The Project software in use must be compatible with the <i>Cimplicity</i> and PLC software in use.<br><br>Look on the Main Menu screen for your software version. |
| PLC software                  | Software programmed into the PLC by MiTek  | The PLC software in use must be compatible with the Project software in use.<br><br>Look on the PLC Status screen for your software version.                      |

MiTek optional software significantly enhances the performance of the saw by allowing the operator to use batch cutting files. Using batch cutting files gives the operator the ability to analyze many trusses at once and download the files to the saw.

The operation of the software listed in Table 3-3 is **not** covered in this manual. Contact MiTek’s software technical support team for assistance with any optional software.

**Table 3-3: Optional Software**

| Software                     | Description   |
|------------------------------|---|
| <i>CyberSort<sup>™</sup></i> | Part of the <i>MiTek 20/20<sup>®</sup></i> suite; reads multiple input file formats and turns them into CYB or EZY file for the A/T or a variety of other output files for other companies’ equipment |
| Job Summary                  | Works with <i>CyberSort</i> to create EZY or CYB files  |
| <i>MBA<sup>™</sup></i>       | Management software that handles orders, jobs, costs, etc.  |
| <i>MVP<sup>™</sup></i>       | Production management tool that enhances <i>MBA</i> to extend it out to the shop; intended for a paperless environment  |

# Operation Part 2: Operating Procedures

## Quick Start: An Operating Overview



**Refer to...**

Page OP-76 for screen overviews

Page OP-53 for an explanation of each step

Appendix D for a daily checklist

This section summarizes the normal operation of the *Cyber A/T* saw in Automatic Mode. The procedure is defined in more detail in subsequent sections.

These instructions assume that both disconnect handles were turned to the off position at last use.

| <b>DANGER</b>   |   |
|---|---|
|  | <p><b>Before turning on the equipment, make sure that all personnel and equipment are out of the restricted zone (see page OP-10 or OP-26).</b></p> |

1. Perform daily startup procedures:
  - a) Turn power on to the saw, the computer, the monitor, and any optional accessories installed.
  - b) Perform the pre-operation safety check.
  - c) Check everything listed in the maintenance checklist titled *At the Beginning of Each Shift* on page MT-235.
  - d) Clear all emergency stops and faults.
2. Set up the saw.
  - a) Load the batch cutting files.
  - b) Set the infeed conveyor offset.
3. Attach needed supports.



4. Start the conveyors and saw blades.

| <b>WARNING</b>  |   |
|---|---|
|  | <p><b>CUT AND CRUSH HAZARD.</b></p> <p><b>AIRBORNE PARTICLES, CHEMICALS, AND LOUD NOISE HAZARD.</b></p> <p><b>Do not enter the area between the infeed conveyors when the saw is operating. Serious injury and/or death could occur due to rotating saw blades and conveyors traveling along the rail.</b></p> <p><b>Wear ear and eye protection for all cleaning activities.</b></p> <p><b>When using cleaning and lubrication solutions, wear a properly rated respirator and gloves.</b></p> |

5. Feed the lumber onto the infeed conveyor and remove it from the outfeed side.
6. Clean the saw every 2 hours, per the maintenance checklist titled *Every 2 Hours* on page MT-236.
7. When done for the day, shut down the saw and the computer.

Figure 3-5: Overview of Operating Procedure in Automatic Mode

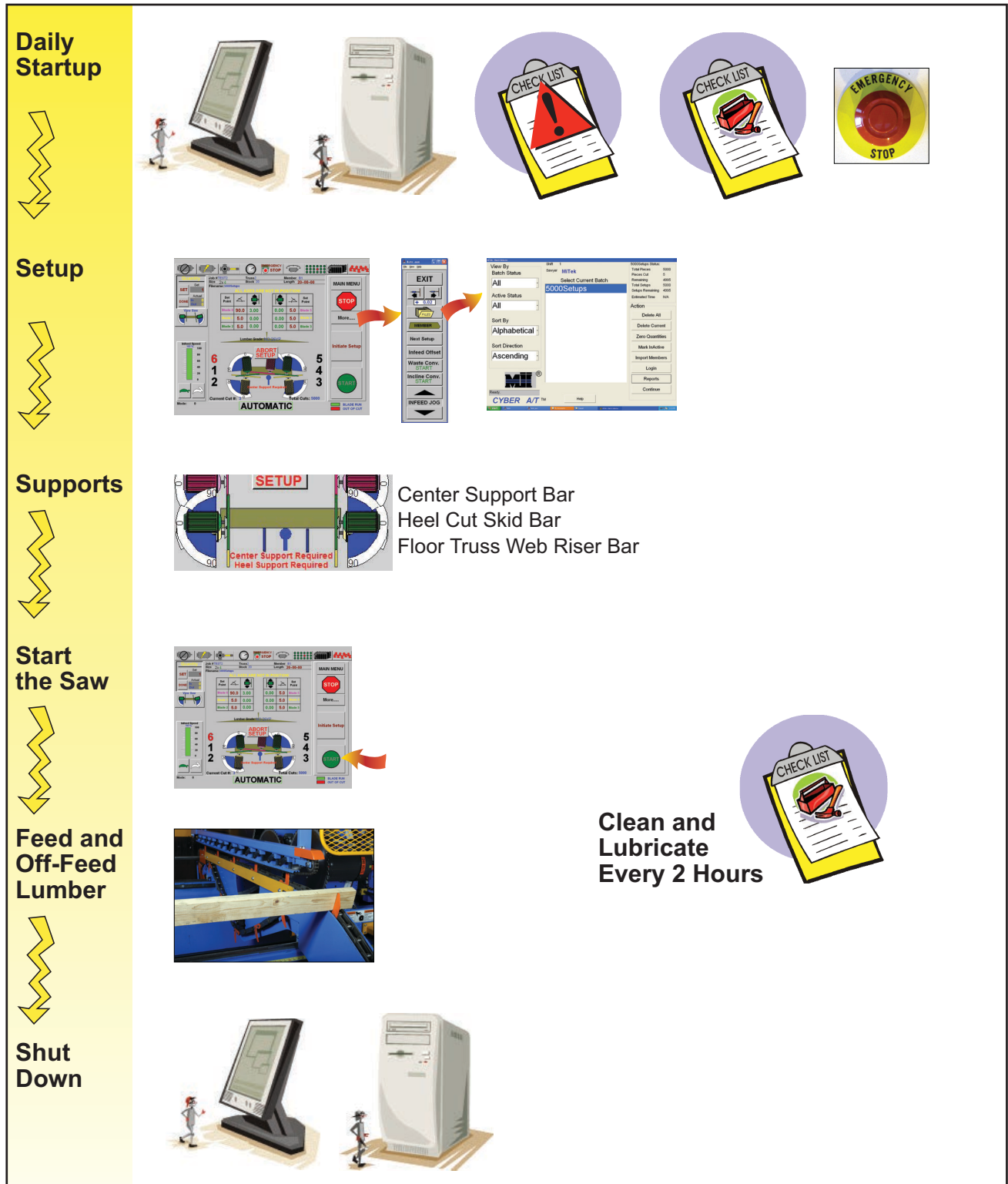

## Using the Manual and Semiauto Screens

### Entering Numerical Data

In Manual Mode, use the arrow buttons on the touch screen to adjust the settings. There is a slight pause between the time your finger touches the screen and the movement of the components when in Manual Mode. Hold your finger on the screen until the component is at the desired location.

In Semiauto Mode, enter the number on the keypad on the touch screen to adjust the settings. All adjusted components will move when you press the INITIATE SETUP button.

**Table 3-4: Entering Numerical Data (Does Not Apply to the Calibration Screen)**

| Item to Measure                               | Measurement System | Structure of Data   | If Your Number is This... | Enter This... |
|---|--------------------|---|---------------------------|---------------|
| Centerlines, infeed conveyors, and hold-downs | Imperial (English) | Enter the first 2 digits as the whole number in inches and the second 2 digits as a fraction in sixteenths of an inch | 11-1/2" = 11-8/16"        | 1108          |
|   |                    |   | 5-1/4" = 5-4/16"          | 0504          |
| Carriage length                               | Imperial (English) | 1st and 2nd digits: whole number in feet  | 12' 5-7/16"               | 120507        |
|   |                    | 3rd and 4th digits: whole number in inches  | 10' 1/2" = 10' 8/16"      | 100008        |
|   |                    | 5th and 6th digits: fraction in sixteenths of an inch   |                           |               |
| Board height                                  | Imperial (English) | Enter the height of the board, as it will be when placed on the infeed conveyor                                       | 2x4                       | 4             |
|   |                    |   | 2x8                       | 8             |
|   |                    |   | 4x2                       | 2             |
| Centerlines, infeed conveyors, and hold-downs | Metric             | Enter in millimeters (mm)   | 5 cm = 500 mm             | 500           |
|   |                    |   |                           |               |
| Carriage length                               | Metric             | Enter in centimeters (cm)   | 300 cm                    | 300           |
| Angle   | Degrees            | Enter with 1 digit past an implied decimal point  | 90°                       | 900           |
|   |                    |   | 5.2°                      | 052           |

## Operating Procedure in Manual and Semiauto Mode

1. Refer to the *Operation Part 3: Software Screens* section to determine which section of the screen applies for the desired adjustment.
2. Set the desired location for the component:
  - In Manual Mode, press the directional button.
  - In Semiauto Mode, press the component button, enter the numerical data as described in the *Using the Manual and Semiauto Screens* section. After all set points are entered, press INITIATE SETUP to move all axes to their set points.
3. Start the operation of the saw blades and infeed conveyor:
  - In Manual Mode, press each blade start button (START 1 through START 6) and the conveyor start button (INFEED CONV. START) to start each component in motion.
  - In Semiauto Mode, press the green START button to sequence all blades and the infeed conveyor on.
4. Press the waste conveyor start button (WASTE CONV. START) to put the waste conveyor in motion.
5. If your saw has an optional incline conveyor, press the incline conveyor start button (INCLINE CONV. START) to put the incline conveyor in motion.
6. When all boards are cut, stop the saw. If a quantity was entered in Semiauto Mode, the saw will stop automatically. If not, press the STOP button to stop all blades and the infeed conveyors.

## Operating Procedures: Daily Startup

### Turning On the Saw



You may hear a “click” in the electrical cabinets. This is a normal sound caused by power relays being pulled in.

1. Turn on the main disconnect or circuit breaker in your facility which supplies power to the saw (this may not be necessary at your facility).
2. Move the saw’s main power disconnect handle from the off position (down) to the on position (up) on the stationary side of the machine.
3. Check the air supply.
  - a) Check to see that compressed air is connected to the saw and the air gauge reads at least 100 psi. If it does not, check to see that the compressor feeding the saw is on.
  - b) Check to see that there is oil in the lubricator. The bowl should be between 1/4 and 3/4 full.
  - c) Check that there is no water in the separator. Drain the bowl if necessary.

### Turning On the Computer and Monitor

To change to the screens to English or Spanish language, refer to the *Selecting a Language* section on page MT-113.

### Computers Inside the Touch Screen Enclosure

1. Check that there are no disks in the floppy drive.
2. Open the rear of the computer enclosure. Use a large slotted screwdriver to turn the latches if the door is latched closed.

Figure 3-6: Power Buttons Inside the Touch Screen Enclosure

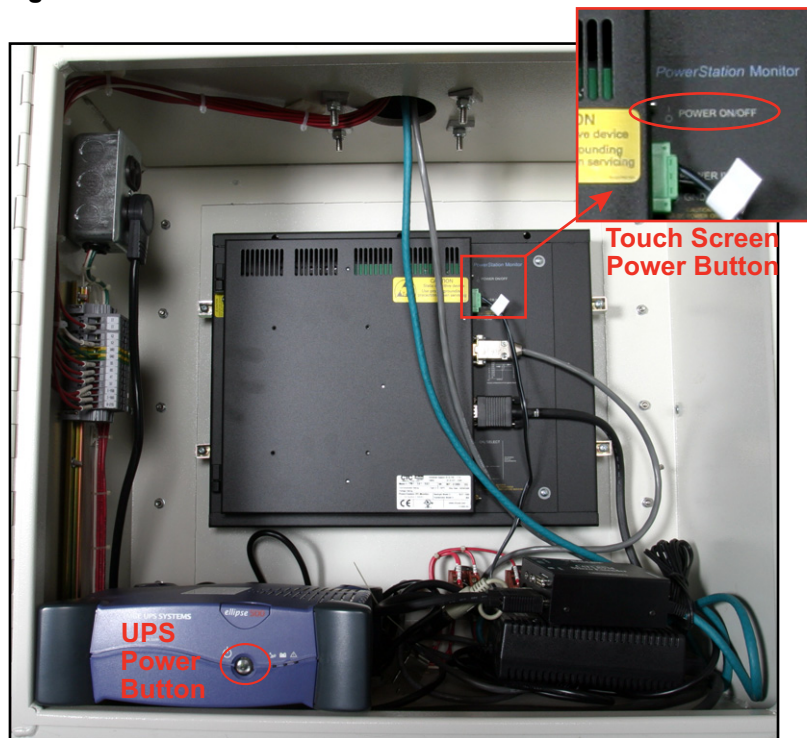

The power button will turn green even if there is no power to the machine.

3. Turn on the UPS (uninterruptible power supply) by pressing the ON button. The button will illuminate to indicate that the unit is on.
4. Turn on the touch screen computer by toggling the rocker switch to the ON position.

ON is marked with a straight line and OFF is marked with “0”.

The logon to Windows dialog will display with SAWYER as the user name and the password field will be blank.

5. Press OK.
6. The *Cimplicity* Project screen will appear. Press START to load the default project.
  - a) If you have Project version 12.0 or later, a language selector screen will appear.
  - b) Choose the language you want the screen to display in: English or Spanish.
  - c) Refer to the *Selecting a Language* section on page MT-113 for more instructions regarding the language selector screen.

7. Wait for the screen to display a picture of the saw.
8. Touch the screen to begin.

### Computers Inside a PC Enclosure

1. Check that there are no disks in the floppy drive.

**Figure 3-7: Power On Buttons**



2. Open the door on the PC enclosure.
3. Turn on the UPS by pressing the ON button labeled “1” in Figure 3-7. The button will illuminate to indicate that the unit is on.
4. Turn on the computer by pushing in and releasing the button on the front of the PC tower. The button is labeled “2” in Figure 3-7.
5. Turn on the touch screen monitor by opening the door on the back of the touch screen enclosure and pushing the toggle switch up. Figure 3-7 shows the toggle switch in the up position, which is the POWER ON position.

On the monitor’s screen, the logon to Windows dialog will display with SAWYER as the user name and the password field will be blank.

6. Press OK.

The *Cimplicity* Project screen will appear.



The power button turns green even if there is no power to the enclosure because it has a backup battery.

7. Press START to load the default project.
  - a) If you have Project version 12.0 or later, a language selector screen will appear at this point.
  - b) Choose the language you want the screen to display in: English or Spanish.
  - c) Refer to the *Maintenance* manual for more instructions regarding the language selector screen.
8. Wait for the screen to display a picture of the saw.
9. Touch the screen to begin.

## Pre-Operation Safety Check

### Safety Tests

Perform the safety tests described on page OP-12 every day, before operating the saw, as well as after performing any maintenance. See page OP-28 for the Spanish translation of the safety tests.

### Performing Daily Maintenance

Refer to the *Maintenance Checklists* appendix for a list of preventive maintenance items that must be done before starting up the saw and every two (2) hours.

### Clearing E-Stops and Faults

To clear E-stops, see the *Overview of Emergency Stops (E-Stops)* section on page OP-44.

To clear faults, see the *Alarm Conditions Menu* section on page OP-97.



## Operating Procedures: Setup

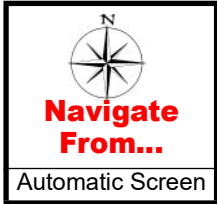

### Loading and Deleting Batch Cutting Files

#### Loading EZY files

1. In the Automatic Menu, press MORE.
2. Press FILES. The Batch Selector screen appears.
3. If loading files from a floppy, insert the floppy disk containing the batch files into the floppy drive.
  - If the saw's computer is located in a separate PC enclosure, the floppy drive is located on the front of the PC enclosure.
  - If the saw's computer is inside the touch screen enclosure, the floppy drive is also located there.
4. Press IMPORT MEMBERS.
5. Select the drive that corresponds to the network, hard disk, or floppy drive.
  - a) Press the down arrow on the screen and slide your finger down until the correct drive is highlighted.
  - b) Remove your finger from the screen.
6. Select a subfolder (subdirectory) by double tapping the folder(s) with the batch files.
7. Select the file name from the list on the right side of the screen.
8. If the imperial or metric check box is showing, ensure the correct box is checked.

*For most software versions, this setting is made in the Defaults settings instead of here.*
9. Press OPTIONS.
10. Select the options you want when the saw imports the batch file, and press DONE when finished.
11. Press IMPORT ALL to import all data from the EZY files listed or IMPORT to import data from only the highlighted EZY files.
12. Press BACK to return to the previous screen.
13. Select the batch to be cut by touching the batch in the list so that it is highlighted.

- Once a batch(es) is highlighted, the NO SELECTION button will change to CONTINUE. Press CONTINUE to cut the batch(es) selected. This will return you to the Automatic Menu.

The first piece in the batch will load automatically.

### Deleting Batch Files

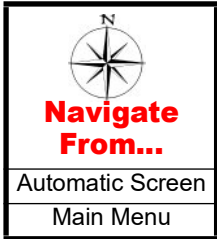

At the end of the work day, or at least on a weekly basis, clear the EZY files from the machine.

Figure 3-8: Choosing the Batch File

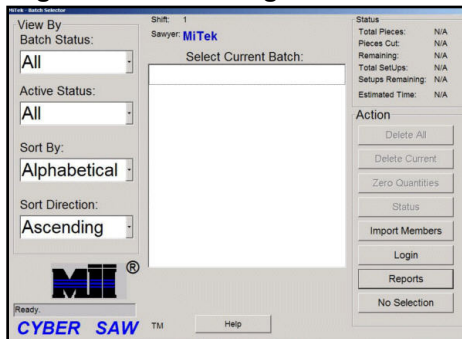

- From the More screen on the Automatic screen or from the Main Menu, press FILE to open the Batch Selector screen.
- In the Batch Status field, select CUT. This will display all batches that were completely cut. Partially cut batches are not displayed.
- Press the DELETE ALL button, and all listed batches will be deleted.
- Press CONTINUE to return to either the Automatic screen or the Main Menu.

### Setting Infeed Conveyor Offset

Refer to the *Setting the Infeed Conveyor Offset* section on page OP-68.

## Operating Procedures: Using Supports

### Using the Center Lumber Support

The center lumber support supports the lumber between the infeed conveyors to prevent it from sagging. It improves the accuracy and consistency of the cuts on longer pieces by preventing the lumber from bowing downward along its length while being cut. It helps ensure that the angle and centerline are accurately cut.

### When to Use the Center Lumber Support

Use the center lumber support for all lumber with a centerline length longer than 10 ft.

In Automatic Mode, an indicator and text message appear when a center lumber support is required. In the Semiauto Mode, only a graphic displays, as shown in Figure 3-9.

**Figure 3-9: Display Graphic Indicating the Need for a Center Lumber Support or Heel Cut Skid Bar**

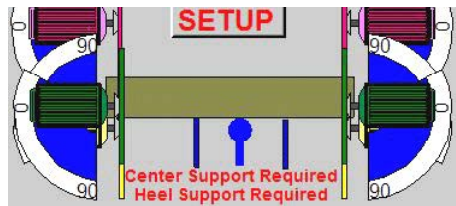

### How to Attach the Center Lumber Support

Refer to Figure 3-10. Place each end of the center lumber support in the V-track on opposite sides of the saw under where the center of the board will be. Place a straight 2x4 on the infeed conveyor. Use the adjustment bolts on the foot of the center lumber support to adjust the height so the support is 1/8-1/4 in. below the bottom of the board.

**Figure 3-10: Attaching the Center Lumber Support**

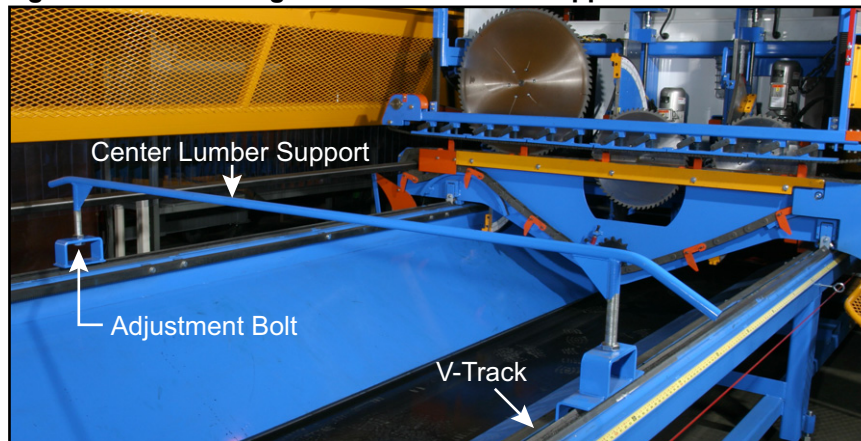

## Using the Heel Cut Skid Bar

The heel cut skid bar supports the end of the lumber, between the saw blade and the infeed conveyor.

### When to Use the Heel Cut Skid Bar



**Remember:**  
When using blade 5 or 6, slow down the infeed conveyor speed. A maximum of 80% of the normal speed is a good rule to follow.

The heel cut skid bar is required for long scarf cuts, specifically when the centerline length is over 6 ft with an infeed offset of 12 in. or more. If the saw has five (5) blades, one (1) heel cut skid bar comes with the saw. If the saw has six (6) blades, two (2) heel cut skid bars are provided.

In Automatic Mode, there is an indicator for each end of the saw and a text message that appears when a heel cut skid bar is required. In the Semiauto Mode, only a graphic displays, as shown in Figure 3-9.

### How to Attach the Heel Cut Skid Bar

Refer to Figure 3-11. The heel cut skid bar should be set as close to the blades as possible, while maintaining a safe clearance between the heel support and the blades.

The heel cut skid bar must be level with the infeed conveyor. Use the adjustment bolts on the foot of the bar to adjust the height. Place each end of the heel cut skid bar in the V-track on opposite sides of the saw, under the end of the board you wish to cut. If using one (1) heel cut skid bar, it should be placed at the carriage end. If using two (2) bars, place one (1) on the carriage end and one on the stationary end.

**Figure 3-11: Attaching the Heel Cut Skid Bar**

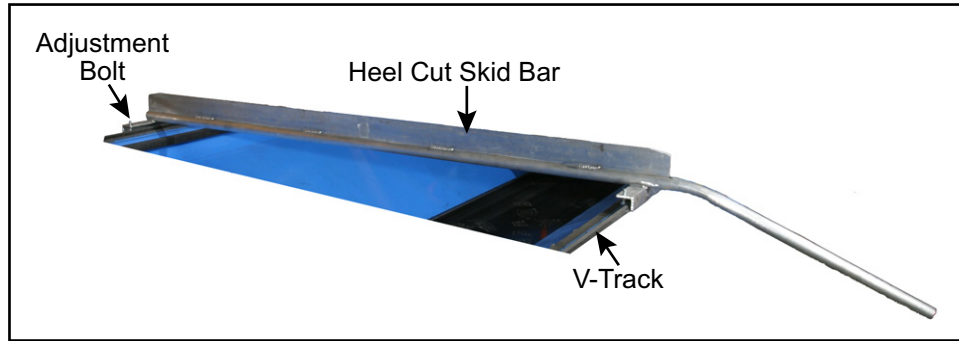

## Using the Floor Truss Web Riser Bars



In Automatic Mode: Adjust the On Flat Centerline Adjust setting in *CyberSort*.

In Manual or Semiauto Mode: Increase the centerline settings by 3/16 in. to accommodate the lumber riding on top of the feed chains.

The floor truss riser bars are for cutting floor truss webs and other pieces when the lumber is fed through the saw with one of its broad sides facing up (see Figure 3-12). The riser bars lift the board up to avoid the notch in the flights and prevent the lumber from tilting front to back, which could cause the cuts to be unparallel with the face of the board.

### When to Use Floor Truss Web Riser Bars

Use the floor truss web riser bars any time the orientation of the board fed through the saw is as shown in Figure 3-12. Most floor truss webs require this orientation.

**Figure 3-12: Board on Infeed Conveyor for Floor Trusses**

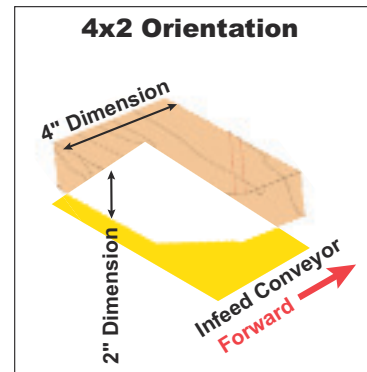

### How to Attach Floor Truss Web Riser Bars

Refer to Figure 3-13. Attach the floor truss web riser bars to the outside of each infeed conveyor using 5/16-18-in. hex head screws (customer-supplied). Each bar requires two (2) screws, one on each end.

**Figure 3-13: Attaching the Floor Truss Web Riser Bars**



## Operating Procedures: Begin Sawing



This procedure applies to Automatic Mode only.

1. Ensure all setup tasks are complete and supports are in place.
2. Ensure the material handlers and equipment on the outfeed side of the saw are ready.

|   |  |
|---|--|
|   | <b>WARNING</b>   |
|  | <p><b>STOP!</b></p> <p>Ensure that all personnel are out of the restricted zone area. See page OP-10 to see the restricted zone.</p> |

3. From the More menu, turn on the waste conveyor (WAST CONV. START).
4. If your saw has an optional incline conveyor, turn it on from the More menu also (INCLINE CONV. START).
5. Press START and all blades and the infeed conveyor will start.
6. Don't forget to clean the saw every 2 hours.

|   |  |
|---|--|
|   | <b>CAUTION</b>   |
|  | <p><b>AIRBORNE PARTICLES, CHEMICALS, AND LOUD NOISE HAZARD.</b></p> <p>Wear ear and eye protection for all cleaning activities.</p> <p>When using cleaning and lubrication solutions, wear a properly rated respirator and gloves.</p> |

## Operating Procedures: Feeding and Removing Lumber

| <b>DANGER</b>   |  |
|---|--|
|  | <p><b>CUTTING HAZARD.</b></p> <p>Do not attempt to hand-hold lumber pieces that are too short for the automatic lumber feed conveyor during a cutting operation.</p> <p>Do not operate the saw in a manner that requires your hands to move past the plane of the guards. See page OP-11.</p> <p>Mishandling of lumber near the saw blades could result in severe injury or death.</p> |

### Direction of Lumber

Figure 3-14 shows a 2x4 orientation versus a 4x2 orientation when placed on the infeed conveyor.

- Roof truss webs are generally placed on the infeed conveyor in a 2x4 orientation.
- Floor truss webs are generally placed on the conveyor in a 4x2 orientation.

**Figure 3-14: 2x4 Orientation vs. 4x2 Orientation**

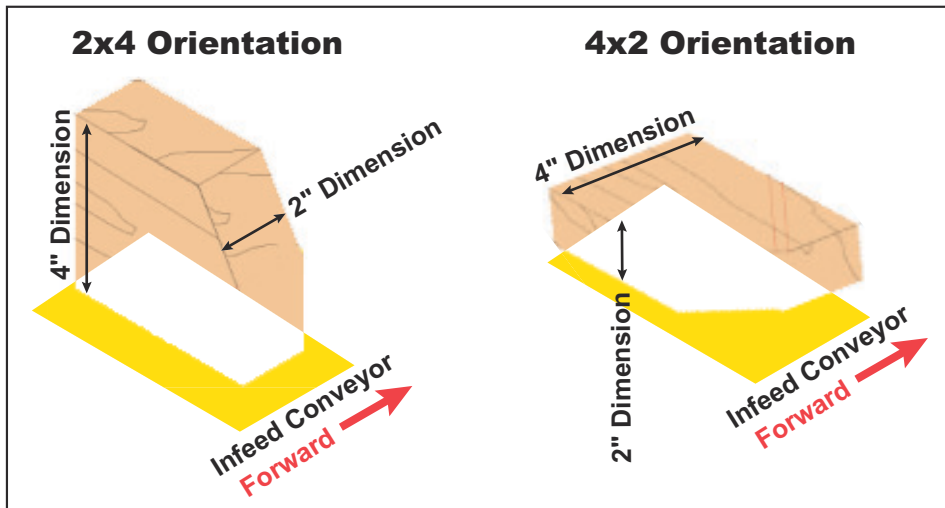



## Tips for Faster Feeding

- The infeed system is designed for one or two (1-2) people to feed lumber into the saw. With longer lumber, it will be faster and safer with two (2) people, but with experience, one person is able to feed the lumber.
- Use a cart or conveyor system as a holding area for the lumber that is to be cut. The lumber should be stacked neatly at approximately the same level as the lumber pivot extensions.
- The flights on the lumber conveyor carry the lumber to the saw blades. You may try to place a board between every pair, or you may decide to skip one or more flights between lumber pieces.
- Adjust the infeed conveyor speed using the INFEED SPEED dial on the operator station so the conveyor is moving at a speed comfortable for your infeed operators. The comfortable speed varies with the length of lumber and with individual operators.

**Figure 3-15: Parts Used When Feeding Lumber**

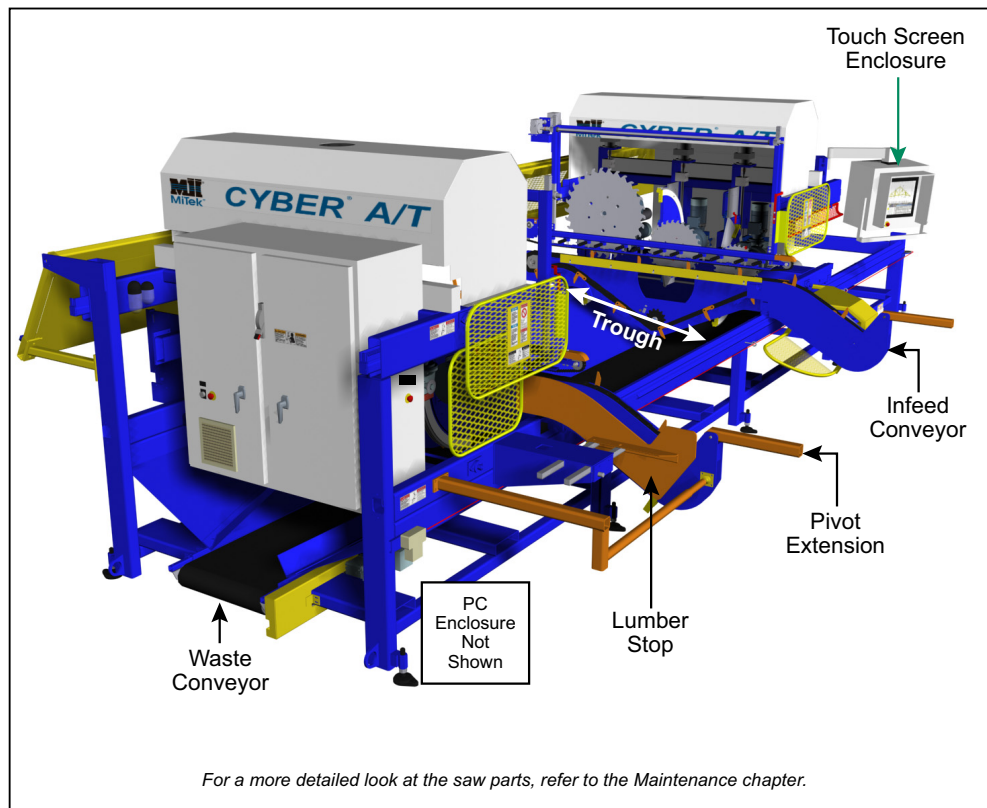

## How to Feed the Lumber

### Feeding Procedure for Short Lumber

Note the number of pieces to be cut, the stock length to be fed, and the grades and species of lumber.

The shorter the lumber, the easier it will be to feed it. One person may be able to keep up easily. When you are having difficulty keeping up with the desired speed, refer to the procedure for long lumber or assign a second person to help.

**Figure 3-16: Infeed Conveyor Carrying Lumber in 2x4 Orientation**



### Feeding Procedure for Long Lumber

1. Note the number of pieces to be cut, the stock length to be fed, and the grades and species of lumber.
2. Place as many pieces of lumber onto the lumber pivot extensions as will fit comfortably.

3. Place the lumber, one piece at a time, onto the conveyor extensions between the flights. The flights will begin carrying it toward the saw blades.

| <b>WARNING</b>  |  |
|---|--|
|  | <p><b>PINCH HAZARD!</b></p> <p><b>Place the lumber onto the conveyor extensions between lumber flights after the flights turn and are in a vertical position. Do not attempt to place the lumber directly on a flights.</b></p> <p><b>Serious injury may result if your hand comes into contact with the flights or infeed chains.</b></p> |

- a) Push-and-pivot method:
  - 1) Standing at the carriage end, slide the end of one piece of lumber down onto the conveyor extension.
  - 2) Push down on the closest end of the lumber, using the conveyor extension as a fulcrum point so the other end raises up.
  - 3) Continue to push your end of the lumber down and away from the saw until the opposite end of the lumber falls onto the stationary-end conveyor extension.
  - 4) Release your end of the lumber.
- b) Roll method:
  - 1) Standing at the carriage end, roll each board toward the saw so both ends fall simultaneously onto the conveyor extensions.
  - 2) Release your end of the lumber.

4. Continue until all the pieces for the setup have been fed into the saw.

## **How to Remove the Lumber at the Outfeed Side**

Outfeed arms are supplied with standard saws to catch the lumber on the outfeed side after it is cut. In most instances, one (1) person should be able to raise the lumber up off the outfeed arms and place it on a cart or conveyor system. Multiple people may be required depending on the size of the lumber and the speed of the saw.

MiTek offers optional conveyor systems that replace the outfeed arms so the cut boards fall directly onto the conveyor.

## Other Operating Procedures

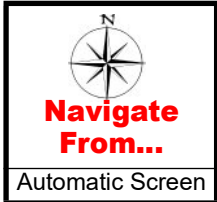

### Choosing Which Member to Cut

Access the Member Selection screen from the Automatic screen by pressing the MORE button.

The Member Selection screen allows the operator to view all the members within the current batch. During normal operation, the first uncut member is loaded for setup. From the Member Selection screen, any member can be selected for setup. See the *Member Selection Screen* section on page OP-91.

### Choosing Which Batch to Cut

Access the Batch Selector screen from the Automatic Menu by pressing the MORE button. See the *More Screen* section on page OP-89.

### Setting the Infeed Conveyor Offset

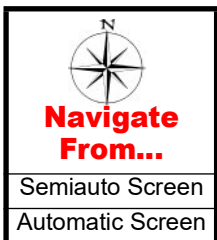

If you want the saw to set up the infeed conveyor farther away from the blades to provide additional leverage when loading boards, set an infeed conveyor offset.

#### When to Use the Infeed Conveyor Offset

If you must use infeed offset, set it for the minimum amount possible. The closer the infeed conveyor is to the blades, the more accurate the cut will be.

There is an option checkbox to ignore the use of the infeed offset. If blades 5 or 6 are in-the-cut, turn OFF the infeed offset.



#### How to Set an Infeed Conveyor Offset

Access the Infeed Offset setting from the Semiauto screen>View Saw or from the Automatic screen>More.

1. From the More screen on the Automatic screen, press INFEED OFFSET.
2. Select the amount of offset for both ends. It is available in 6-in. increments from 0 to 18 in. (6 in. is typical).
3. Press EXIT to return to the Automatic screen.

The saw ignores the Infeed Conveyor Offset setting when the board is under 6 ft long.

## Starting the Blades

Refer to page OP-48 for Automatic Mode or the *Operation Part 3: Software Screens* section on page OP-76 for Manual and Semiauto Mode.

## Operating a MiTek Inker or Catcher Display

If you have an optional peripheral device such as the *MiTek* Inker and/or Catcher Display, refer to its manual for operation and maintenance. It should operate whenever the saw is operating in Automatic Mode and the peripheral device is turned on.

## Resetting Alarms and Faults

Each alarm or fault must be reset individually. Refer to the *Alarm Conditions Menu* starting on page OP-97 for instructions.

## Selecting a Language for the Software

For Project versions 12.0 or later, you can choose to display all text in English or in Spanish. The default setting is to display in English and automatically display a language selector screen when you turn on the saw computer, after logging into Windows. When the language selector screen appears, choose the language you want the software to display and press OK.

To prevent the language selector screen from appearing every time you logon, click the DON'T ASK ME AGAIN box before hitting OK. This option sets the language chosen at the time as the default, and the screen will not appear again until you manually change it.

To manually change the language after the DON'T ASK ME AGAIN box has been clicked on, double click the shortcut on your desktop called CYBER AT CHANGE LANGUAGE. The language selector screen appears, and you can change the language and/or click the DON'T ASK ME AGAIN box off.

To change the language after logging in, shut down Project. When you restart it, either the language selector screen appears or you can use the CYBER AT CHANGE LANGUAGE shortcut on the desktop.

The check box itself cannot be removed. The operator always has the option to change languages.

## Adjustments During Operation

The following procedures refer to Manual Mode and Semiauto Mode only. These settings are automatically adjusted when operating in Automatic Mode.



In Manual Mode, use the arrow buttons on the touch screen to adjust the settings.

In Semiauto Mode, enter the number on the keypad on the touch screen to adjust the settings.

For recalibrating the centerline or angle settings, see the *Calibration Check* section starting on page MT-49.

### Adjusting the Centerline or Angle of a Saw

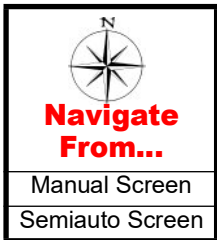

In this example we will use blade 1, but the process is the same for all blades.

1. To adjust the blade motor centerline, use the buttons on the right to raise or lower the pivot point.
2. To adjust the blade motor angle, use the buttons on the left to increase or decrease the angle.

The reading below the buttons displays the actual position of the setting.

Blades 5 and 6 also has an IN and OUT button. When these blades are not in use, they should be in the out position. When needed, pushing the IN button will bring them into the cut.

Figure 3-17: Adjusting the Centerline in Manual Mode

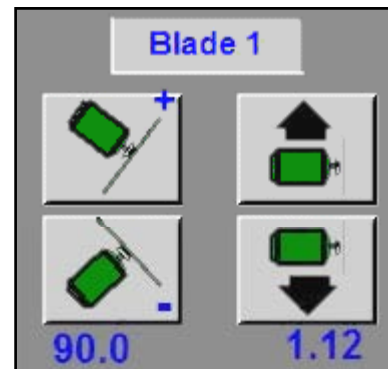

## Adjusting the Position of the Infeed Conveyors



You can adjust the horizontal location of the infeed conveyors in Manual Mode.

From the Manual screen, press the appropriate button to move the conveyor in the correct direction. The reading below the buttons displays the actual position of the infeed conveyors from the saw blades.

Figure 3-18: Adjusting Infeed Conveyors

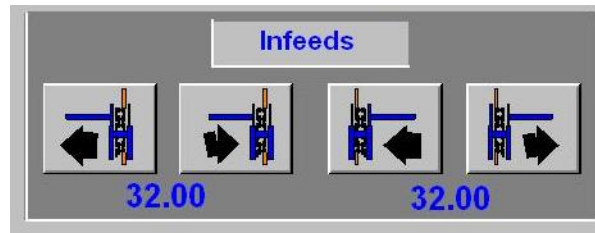

- To adjust the infeed conveyors on the stationary end, use the two buttons on the left in Figure 3-18.
- To adjust the infeed on the carriage end, use the two buttons on the right in Figure 3-18.

When operating in Automatic Mode, the infeed conveyors are set, by default, at a specific distance from the saw blades. To override this automatic setting, refer to the *Setting the Infeed Conveyor Offset* section on page OP-68.

## Adjusting the Position of the Hold-Down



You can adjust the horizontal location of the hold-downs in Manual Mode. See Figure 3-19.

Press the appropriate button to move the conveyor in the correct direction. The reading below the buttons displays the actual position of the hold-downs from the saw blades.

Figure 3-19: Adjusting Hold-Downs

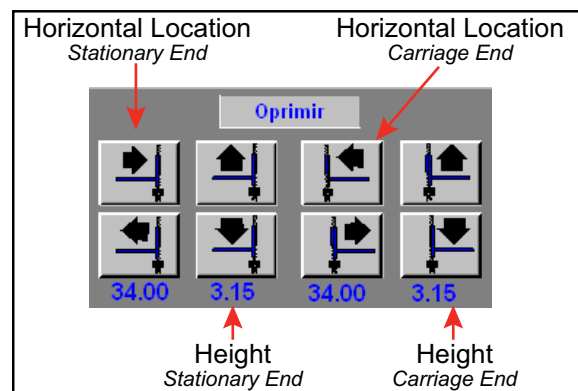

When operating in Automatic Mode, the hold-downs are automatically set to be a specific distance from the saw blades. To override this automatic setting, refer to the *Setting the Infeed Conveyor Offset* section on page OP-68.

## Adjusting the Position of the Carriage

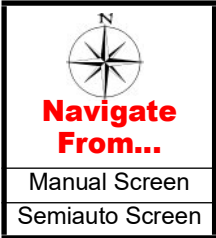

You can adjust the horizontal location of the carriage while in Manual Mode or Semiauto Mode.

Figure 3-20 shows the buttons to use when in Manual Mode. Press and hold the appropriate button to move the carriage in the correct direction. The reading below the buttons displays the actual distance of the carriage saw blades from the stationary saw blades.

**Figure 3-20: Adjusting the Carriage and Lumber Stops in Manual Mode**

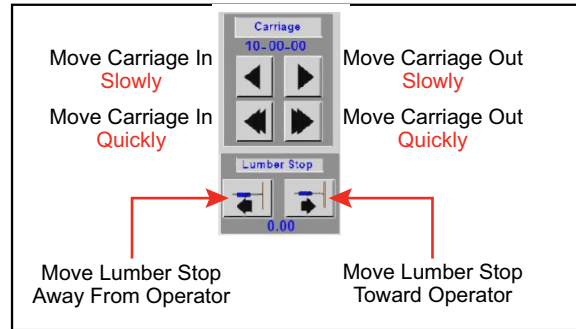

When operating in Automatic Mode, the carriage automatically moves to the correct position for the programmed cut.

## Adjusting the Position of the Lumber Stop

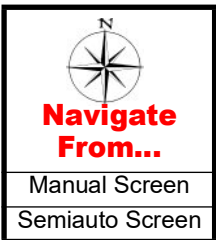

You can adjust the horizontal location of the lumber stop while in Manual Mode or Semiauto Mode. The lumber stop should be located so the board barely grazes blade 2 when traveling along the infeed conveyor.

Figure 3-20 shows the buttons to use when in Manual Mode. Press and hold the appropriate button to move the lumber stop in the correct direction. The reading below the buttons displays the actual position of the lumber stop from the saw blades.

When operating in Automatic Mode, the lumber stop automatically moves to the correct position for the programmed cut.

## Changing Lumber Size

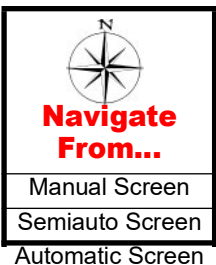

The centerline and hold-down locations are automatically adjusted based on the height of the lumber when it is sitting on the infeed conveyors.

- In Automatic Mode, it automatically has this information from the batch files.
- In Semiauto Mode, press the  button to enter the board height.
- In Manual Mode, manually adjust the height of the hold-downs and the centerline height.



## Adjusting the Speed of the Infeed Conveyors

Adjust the speed of the infeed conveyors by changing the default setting. From the Main Menu, go to Defaults>Speeds.

It is necessary to slow the infeed conveyors to about 80% of normal operating speed when blades 5 or 6 are in-the-cut.

## Moving a Blade In- or Out-of-Cut

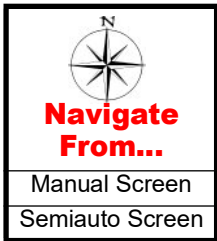

Any blade can be moved completely out of a cut when not needed or returned to the blade assembly when needed. Press the corresponding button as shown in Figure 3-21.

From the Manual screen, only blades 5 and 6 can be moved out-of-cut or in-the-cut.

From the Semiauto screen, any blade can be moved out-of-cut or in-the-cut.

In Automatic Mode, blades are moved in and out automatically based on the batch file data.

**Figure 3-21: Controlling Out-of-Cut and In-the-Cut**

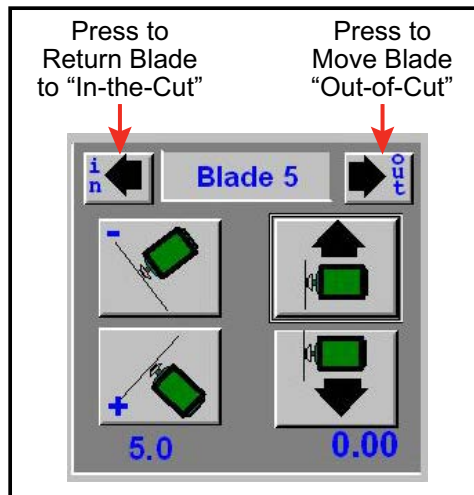

## Overfeeding



### Overfeeding:

The saw counts the number of pieces fed into the saw using an infeed switch and loads the next setup when the correct infeed quantity is reached. The infeed conveyors stop when the outfeed switch recognizes all boards fed into the saw have exited the saw. If the sawyer feeds more boards than required, the infeed conveyor will not stop until all boards are cut and off the saw. This is called overfeeding.

The default setting allows the infeed conveyor to pause and give a warning when overfeeding occurs. The operator must acknowledge the warning for the saw to continue feeding the lumber. If you don't want to continue feeding that board, press STOP and back the board out of the cutting area to remove it.

When the saw counts extra boards on one run, the quantity on the next run will be short. It is recommended that the overfeeding warning be left on at all times so the sawyer is aware of this.

If a qualified maintenance supervisor wants to turn the default warning off, use the Default screen which is shown in Figure 3-34 on page OP-95.

## Operating Procedures: Shutting Down

### Turning Off the Saw

#### During Normal Operation

To cease power to the control circuit and immediately stop all motion, activate an E-stop.

#### At the End of the Day

1. Press the STOP button on the touch screen from either the Manual, Semiauto, or Automatic screen.
2. Press the ALL HOME button on the Semiauto screen to place blades in their home position.
3. Press an E-stop.
4. Turn the disconnect handle on the stationary-end AND carriage-end electrical enclosures to their off positions.



Always place blades in *All Home* position when shutting down. Blades may "cup" if left in a horizontal position for an extended period of time.

## Shutting Down the Computer and Monitor

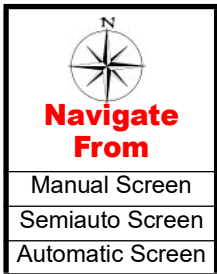

### Computers Inside the Touch Screen Enclosure

1. From the Manual, Semiautomatic, or Automatic screen, touch the MAIN MENU button.
2. Touch the SHUTDOWN button on either side of the screen.
3. A window appears asking if you are certain you want to turn off the screen. Touch the YES button.
4. The computer goes through its shutdown procedure.
5. Once shutdown is complete, a message appears saying it is safe to turn off the computer.
6. Open the door of the computer enclosure and switch off the computer by toggling the power switch to the off (0) position.
7. Push the power button on the UPS.
8. Switch off power at the main power disconnect on the stationary end enclosure.

### Computers Inside a PC Enclosure

1. From the Manual, Semiautomatic, or Automatic screen, touch the Main Menu button.
2. Touch the SHUTDOWN button on either side of the screen.
3. A window appears asking if you are certain you want to turn off the screen. Touch the YES button.
4. The computer goes through its shutdown procedure.
5. Once shutdown is complete, a message appears saying it is safe to turn off the computer.
6. Turn off the monitor.
7. Open the door of the PC enclosure and push the power button on the PC tower.
8. Push the power button on the UPS.
9. Switch off power at the main power disconnect on the stationary end enclosure.

# Operation Part 3: Software Screens

## Main Menu



Screen shots in this chapter were taken from *Cimplicity* Project version 20.11. Other versions may slightly differ.

### Looking Up the Project Software Version

The Main Menu indicates the *Cimplicity* Project version in the lower right corner. In Figure 3-22, the version shows “V20.12”.

**Figure 3-22: Main Menu Screen Alarms Status Bar**

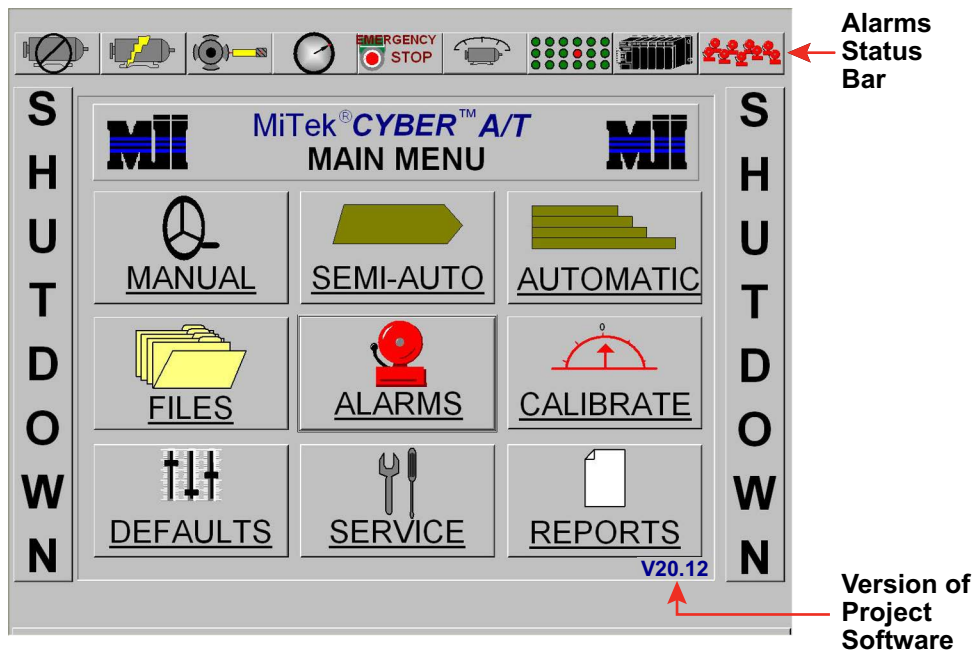

### Alarms Status Bar

An alarms status bar is located at the top of the Main Menu and several other screens. Press an alarms status button when there is no fault showing to quickly access the various alarm status screens. The same screens can be reached through the Alarm Conditions Menu. See page OP-97.

Press one of these buttons when it is flashing red for more information on the nature of the fault.

## Main Menu Buttons

**Manual:**

Enters the saw into the Manual Mode. This mode is used for maintenance of the saw. Here you can adjust any single axis to a desired position. See the *Manual Screen* section on page OP-79 for more details.

**Semiauto:**

Enters the saw into the Semiautomatic Mode. This mode is used for cutting single pieces and certain calibration procedures. See the *Semiautomatic (Semiauto) Screen* section on page OP-83 for more details.

**Automatic:**

Enters the saw into the Automatic Mode. This is the normal operation mode of the saw. In this mode the saw will automatically set up and run production files. See the *Automatic Screen* section on page OP-87 for more details.

**Files:**

This button opens the Batch Selector menu. This is where the EZY files can be loaded into the saw's program. See the *Batch Selector Screen* section on page OP-90 for more details.

**Alarms:**

This opens the Alarm Conditions menu. See the *Alarm Conditions Menu* section on page OP-97 for more details.

**Calibrate:**

This opens the Calibration menu. See the *Calibration Check* section on page MT-49.

**Defaults:**

This will open the defaults screen. You can set system defaults with this menu. See the *Default Screens* section on page OP-93.

**Service:**

This opens a screen used for maintenance purposes. It shows setups and faults for every axis. See the *Maintenance Record Screens* section on page OP-109 for more details.

**Reports:**

This allows you to set up and print reports. See the *Reports Screens* section on page OP-110 or the *Generating Reports* section on page MT-46 in the Maintenance Manual for more details.

**Shutdown:**

The SHUTDOWN buttons on each side of this screen allow the *Cyber A/T* computer to be safely turned off. After touching one of these buttons, *Cimplicity* will prompt with a shutdown confirmation screen. Select YES to shutdown. See the *Operating Procedures: Shutting Down* section for more details.



To avoid possible damage to files, always use the SHUTDOWN button to turn off the computer!

## Alarms Status Bar

The alarms status bar is located at the top of most screens and allows quick identification of problems. Pressing the flashing red fault indicator opens the appropriate alarm screen. See the *Alarm Conditions Menu* screen for details on the alarms.

**Figure 3-23: Alarms Status Bar**



1. Motor overload alarm
2. Motor circuit breaker alarm
3. Proximity switch count alarm and home prox
4. Profibus fault
5. Emergency stop alarm
6. Variable frequency drive alarm
7. Position alarm
8. Programmable controller fault
9. Miscellaneous alarms

## Manual Screen

### Overview

The Manual screen allows the operator to move each axis of the *Cyber A/T* saw. This mode is designed for use during maintenance.

Touching the axis jog button moves that axis in the direction indicated by the arrow. A readout of the actual position of each axis displays below each pair of jog buttons.

| <b>WARNING</b> |   |
|----------------|---|
|                | <p><b>COLLISION HAZARD.</b></p> <p>In Manual Mode, the sawyer must visually monitor the position of all the components of the saw to prevent collisions. The update rate of the actual position shown on the screen may lag behind and should never be used alone during jogging.</p> |

Figure 3-24: Using the Manual Screen

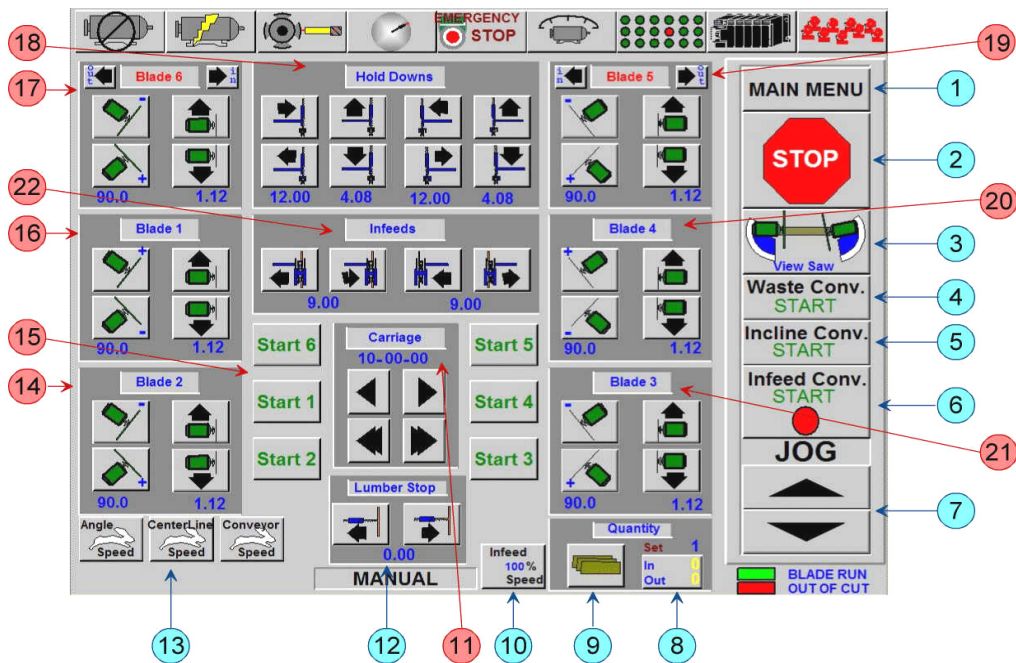

1. MAIN MENU - Opens Main Menu.
2. STOP/START - All blades. The logo toggles between a green START and a red STOP.
3. VIEW SAW - Actual positions of the saw. See Figure 3-25. This button flashes red if a collision zone is detected.

4. WASTE CONV. START - Start/stop the waste conveyor.
  - a) Green Start - Starts the conveyor. When the conveyor is running, a green dot displays.
  - b) Red Stop - Will stop the conveyor. When the conveyor is stopped, a red dot displays.
5. INCLINE CONV. START - Controls the incline conveyor.
  - a) Green Start - Starts the conveyor.
  - b) Red Stop - Stops the conveyor.
6. INFEED CONV. START - Controls the infeed conveyor.
  - a) Green Start - Starts the conveyor.
  - b) Red Stop - Stops the conveyor.
7. FORWARD JOG and REVERSE JOG - Jogs the infeed conveyor.
8. IN/OUT - Displays the current boards-in and boards-out quantities for that run.
9. ADJUST BOARD COUNTERS - Enter quantity to cut. Saw automatically shuts off when quantity is reached. See Figure 3-26.
10. INFEED SPEED - Feed conveyor speed adjustments. See Figure 3-27.
11. CARRIAGE POSITION - These buttons adjust the carriage position (length of the board).
12. LUMBER STOP - These buttons adjust the lumber stop position.
13. SPEED set for:
  - a) Angle speed fast/slow.
  - b) Centerline speed fast/slow.
  - c) Conveyor speed fast/slow.
14. BLADE 2 ADJUSTMENTS - See the *Adjustments During Operation* section on page OP-70.
15. MOTOR START buttons - These buttons start the saw motors.
16. BLADE 1 ADJUSTMENTS - Refer to the *Adjustments During Operation* section on page OP-70.



17. BLADE 6 ADJUSTMENTS- Refer to the *Adjustments During Operation* section on page OP-70. Note the title is in red, indicating that the blade is out of the cut.
18. HOLD-DOWN ADJUSTMENTS - These buttons adjust the hold-downs.
19. BLADE 5 ADJUSTMENTS - Refer to the *Adjustments During Operation* section on page OP-70. Note the title is in red, indicating that the blade is out of the cut.
20. BLADE 4 ADJUSTMENTS- Refer to the *Adjustments During Operation* section on page OP-70.
21. BLADE 3 ADJUSTMENTS - Refer to the *Adjustments During Operation* section page OP-70.
22. INFEEED ADJUSTMENTS - These buttons adjust the infeed conveyors.

Navigate From

|                  |
|------------------|
| Manual Screen    |
| Semiauto Screen  |
| Automatic Screen |

## Sub-Menus Accessed From the Manual Screen

### View Saw Screen

The View Saw screen has several purposes:

- Displays the location of the blades and carriage
- Warns of possible or existing collision situations
- Displays the dimensions of the lumber in the batch
- Allows the operator to change the infeed offset setting



The VIEW SAW button will flash yellow if a collision is predicted, but the saw will still operate. It will flash red if a collision is detected, and the saw will not operate until the Collision Profibus Fault alarm is reset and the collision conditions are changed.

Figure 3-25: View Saw Screen

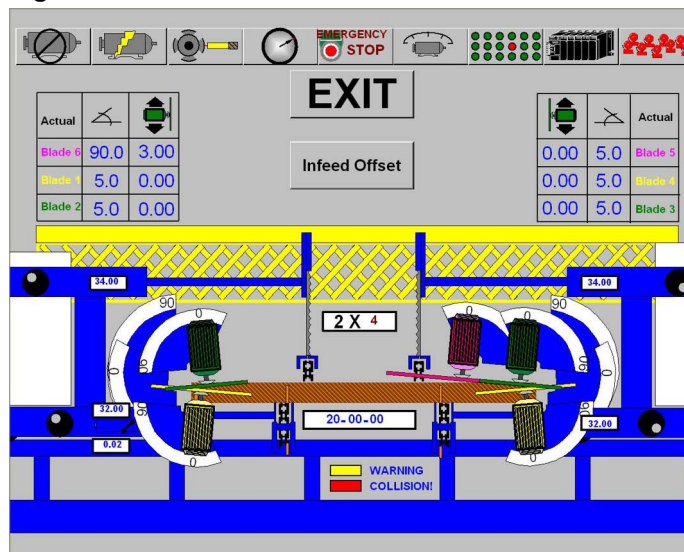

### Adjust Board Counters Screen

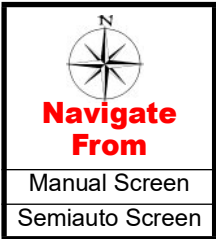

The Adjust Board Counters screen appears when you press the button shown in Figure 3-26 from the Manual or Semiauto screen.

Enter the quantity to cut, and the saw automatically shuts off when the quantity is reached. The quantity must be entered before pressing INITIATE SETUP.

Figure 3-26: Adjusting the Quantity to Cut

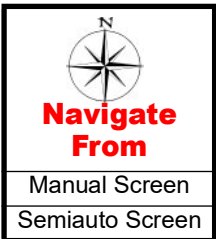
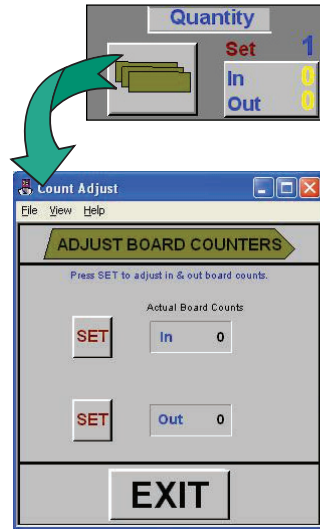

### Infeed Speed Screen

The Infeed Speed screen appears when you press the button in Figure 3-27 from the Manual or Semiauto screen

Press the rabbit to increase the infeed conveyor speed. Press the turtle to decrease the speed.

Figure 3-27: Adjusting the Infeed Conveyor Speed

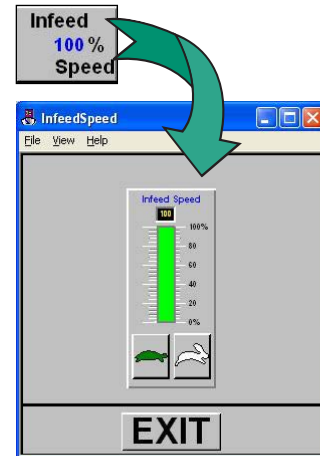

## Semiautomatic (Semiauto) Screen

### Overview



**Refer to...**  
Table 3-4 on page OP-51 explains the format to use for entering numerical data.

The Semiautomatic (Semiauto) screen is very similar in appearance to the Manual screen. The primary difference is the use of the pop up keypad to set the axis locations. The locations of the horizontal hold-downs and infeed conveyors are set automatically when in Semiauto or Automatic Mode. To position an axis, press the component button to bring up the keypad, enter the desired set point, and press the OK button.

Figure 3-28: Using the Semiautomatic Screen

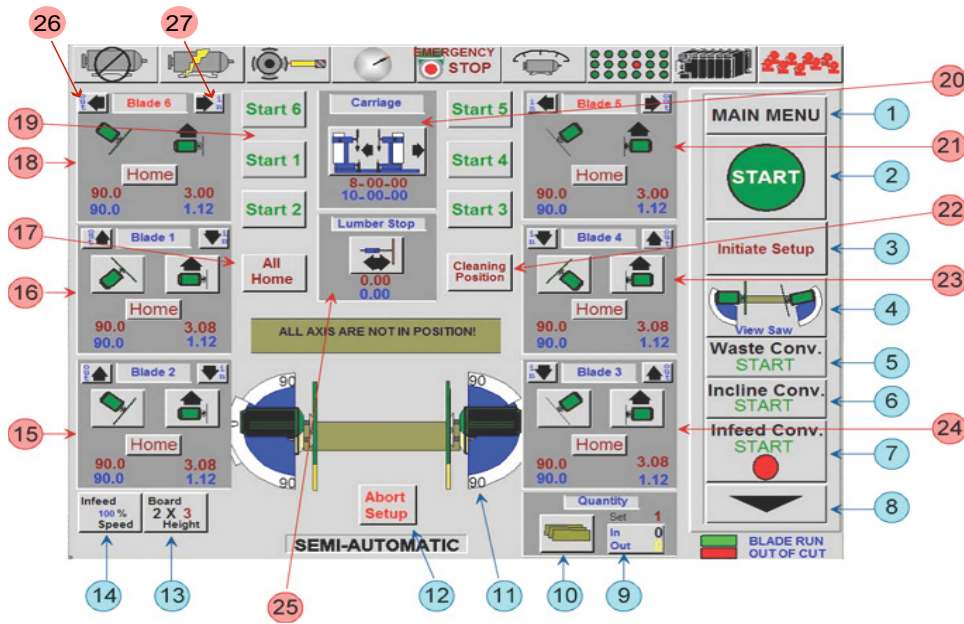

1. MAIN MENU - Returns to the Main Menu.
2. START/STOP
  - a) START - Sequentially starts the blades and the infeed conveyor. Press and hold until the first blade starts.
  - b) STOP - Stops all blades and the infeed conveyor. This button appears only if a blade is running.
3. INITIATE SETUP - Moves all axes locations to the set points.
4. VIEW SAW - View actual positions of the saw. See the *View Saw Screen* section on page OP-81. This button will flash red if a collision is detected or an invalid setup is entered.

Press the ABORT button to reset.

5. WASTE CONV. START - Start or stop the waste conveyor.
  - a) Green Start - Starts the conveyor. When the conveyor is running a green dot will be displayed.
  - b) Red Stop - Stops the conveyor. When the conveyor is stopped a red dot will be displayed.
6. INCLINE CONV. START - Start or stop the incline conveyor.
  - a) Green Start - Starts the conveyor.
  - b) Red Stop - Stops the conveyor.
7. INFEED CONV. START - Press and release the button to start or stop the infeed conveyor. The button toggles between green START and red STOP.
8. INFEED JOG - Reverse jogging of the infeed conveyor.
9. IN/OUT - Displays the current boards-in and boards-out quantities for the run.
10. ADJUST BOARD COUNTERS - Enter quantity to cut. See the *Adjust Board Counters Screen* section on page OP-82. The saw automatically shuts off when quantity is reached. The quantity must be entered before pressing INITIATE SETUP.
11. Saw blade display - Displays the position of the blades.
12. ABORT SETUP - Stops axis positioning.
13. BOARD HEIGHT - This displays a numeric keypad. Enter the height of the board, as it will be when placed on the infeed conveyor.
  - 2x3 = enter 3
  - 2x4 = enter 4
  - 2x6 = enter 6
  - 4x2 = enter 2
14. INFEED SPEED - Adjust the infeed conveyor speed. See the *Infeed Speed Screen* section on page OP-82.
  - a) TURTLE - Holding this button decreases the infeed conveyor speed.
  - b) RABBIT - Holding this button increases the infeed conveyor speed.
  - c) Or touch the center bar for a keypad where the speed can be entered.

15. **BLADE 2 ADJUSTMENTS** - Displays the current position of the blade. If the saw blade is running, the blade number will turn green. If it is not running, the blade number will be red.
16. **BLADE 1 ADJUSTMENTS** - Displays the current position of the blade. If the saw blade is running, the blade number will turn green. If it is not running, the blade number will be red.
17. **ALL HOME** - Moves the blades to default set points for angles and centerlines. Factory default is 90°.
18. **BLADE 6 ADJUSTMENTS** - Displays the current position of the blade. If the saw blade is running the blade number will turn green. If it is not running, the blade number will be red.
19. **MOTOR START** buttons.
20. Carriage settings position set point.
21. **BLADE 5 ADJUSTMENTS** - Displays the current position of each blade.
22. **CLEANING POSITIONS** - Moves blades and centerlines to a pre-defined position where they may be easily cleaned.
23. **BLADE 4 ADJUSTMENTS** - Displays the current position of each blade. If the saw blade is running, the blade number will turn green. If it is not running, the blade number will be red.
24. **BLADE 3 ADJUSTMENTS** - Displays the current position of each blade. If the saw blade is running, the blade number will turn green. If it is not running, the blade number will be red.
25. **LUMBER STOP** - Pressing this button opens a window that allows you to adjust the setting of the lumber stop.
26. **OUT** - Press button to take blade out-of-cut.  
  
The OUT and IN buttons located in the box for the settings of each blade are used to take the blade out of the cut or put the blade in the cut. Out of the cut will automatically set the values for the angle and centerline. When OUT is pressed, the buttons to set the angle and centerline will not be visible until the blade is brought back into the cut by pressing the IN button.
27. **IN** - Press button to put blade in cut (if it was previously moved out-of-cut).

## **Sub-Menus Accessed From the Semiauto Screen**

See the *View Saw Screen* section on page OP-81.

See the *Adjust Board Counters Screen* section on page OP-82.

See the *Adjusting the Infeed Conveyor Speed* section on page OP-82.

# Automatic Screen

## Overview

The Automatic screen reads the set point data from the batch cutting files. All values shown on this screen are set points.



You may notice a blinking error on the Automatic screen saying "Infeed Arm Raised". Ignore this error; it is normal.

**Figure 3-29: Reading the Data Downloaded to the Automatic Screen**

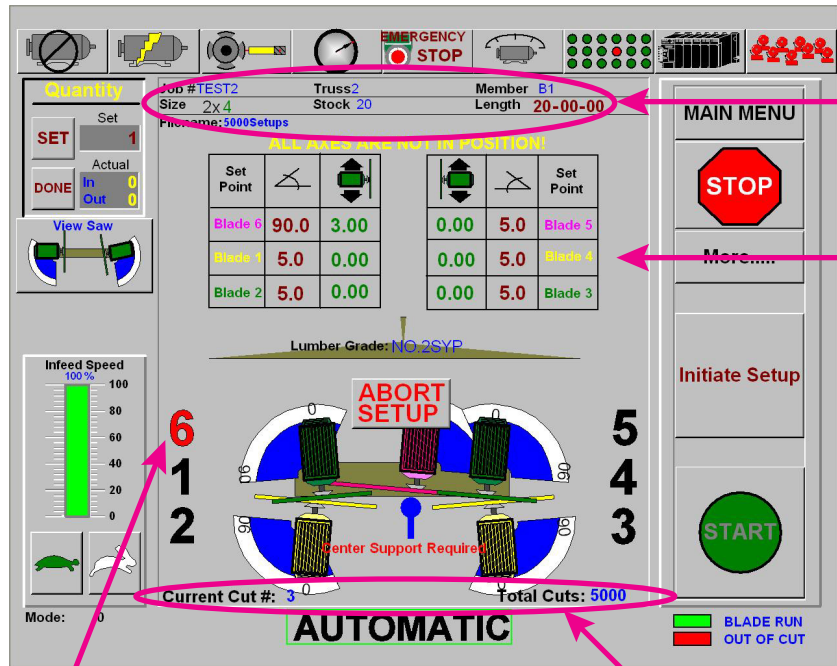

Important information about the current batch.

Saw blade numbers here correspond to color of blades in the graphic.

Red blade # means that blade is out-of-cut.

Shows current and total cuts in the batch currently running or setting up.

Figure 3-30: Using the Automatic Screen

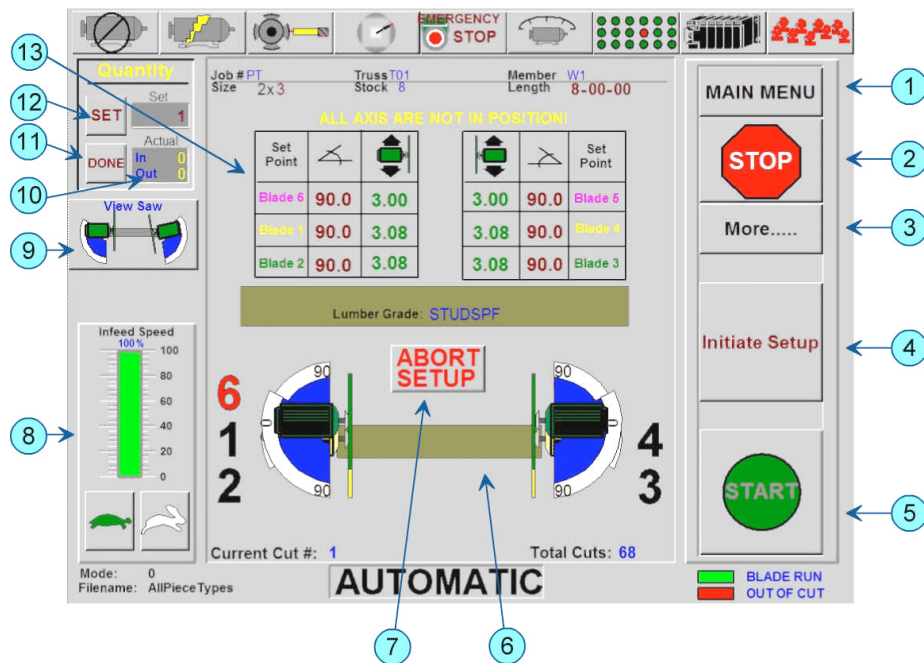

1. MAIN MENU - Opens the main menu.
2. STOP - Stops all blades and the infeed conveyor.
3. MORE - Opens an auxiliary function window. See page OP-89.
4. INITIATE SETUP - Move all axis to the set points.
5. START - Starts all necessary motors. Press and hold until the first blade starts.
6. Saw Blade Display - The saw blades in the center of the screen show the current position of each of the saw blades that will be used. Blades not used in the cut will disappear from the screen.
7. ABORT SETUP - Stops axis positioning.
8. INFEED SPEED - Controls infeed conveyor speed.
  - a) TURTLE - Holding this button decreases the infeed conveyor speed.
  - b) RABBIT - Holding this button increases the infeed conveyor speed.
  - c) Or touch the center bar for a keypad where the speed can be entered.
9. VIEW SAW - View actual positions of the saw. See the *View Saw Screen* section on page OP-81. This button will flash red if a collision was detected or an invalid setup was entered.



Press the ABORT SETUP button to reset.

- 10. IN/OUT - Touching here allows setting of the IN/OUT counts.
- 11. DONE - Indicates that current cut is complete and loads the next setup.

This is an optional button controlled by the .ini file.

- 12. SET - This will pop up a numeric keypad for the board quantity to be entered.

Setting the quantity to zero will reset the in and out counters.

The quantity must be entered before pressing the INITIATE SETUP button.

- 13. Current set points display.

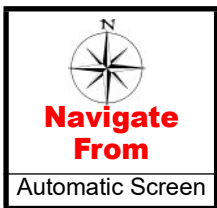

## Sub-Menus Accessed From the Semiauto Screen

### More Screen

- 1. EXIT - Returns to the Automatic Screen.
- 2. LUMBER STOP - Manually adjusts lumber stop.
- 3. FILES - Opens the File (Batch Selector) screen that allows the user to select, load, delete, view statistics, and sort batches.
- 4. MEMBER - Opens the Member Selection screen.
- 5. NEXT SETUP - Loads the next setup.
- 6. INFEEED OFFSET - Adds 0 in., 6 in., 12 in., or 18 in. to the normal blade to infeed clearance.

This feature is disabled when carriage length is less than 6 ft.

- 7. WASTE CONV. - Starts or stops the waste conveyor.
- 8. INCLINE CONV. - Starts or stops the incline conveyor.
- 9. INFEEED JOG- Controls forward and reverse jogging of the infeed conveyor.

### View Saw Screen

See the *View Saw Screen* section on page OP-81.

Figure 3-31:  
More Screen



## Sub-Menus Accessed From the More Screen

### Batch Selector Screen

Access the Batch Selector screen from the FILES button on the Main Menu or from the FILES button on the More Menu.

The Batch Selector screen allows the operator to navigate through the cutting list. It shows the batches that have been cut since the last time batch files were cleared out and the batches that have been downloaded and are waiting to be cut.

**Figure 3-32: Batch Selector Screen**

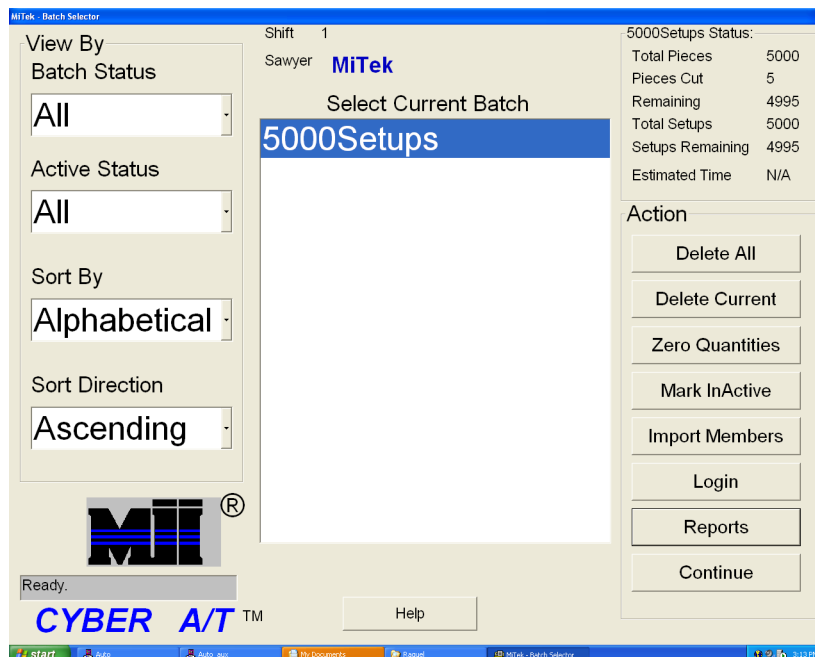

1. DELETE ALL - Deletes all currently listed batches.
2. DELETE CURRENT - Deletes the selected batch.
3. ZERO QUANTITIES - Marks the batch as not cut, allowing it to be cut again.
4. STATUS (MARK INACTIVE) - Marks the selected batch as active or inactive.
5. IMPORT MEMBERS - Allows EZY files to be loaded onto computer from disk or networks drive.
6. LOGIN - Allows sawyer to login by name and assign a shift number for reporting purposes.
7. REPORTS - Opens the REPORTS/STATISTICS screen.

8. NO SELECTION - This button only displays when no selection has been made. Use it to exit the menu. As soon as a selection is highlighted this button will turn into the Continue button.

9. CONTINUE - Returns to Automatic screen.

The “View By” options on the left of the screen allow loaded batches to be sorted and viewed in a variety of ways.

10. Batch Status

- All (View all loaded batches)
- Not Cut (View only batches not completely cut)
- Cut (View only batches that have been completely cut)

11. Active Status

- Active (View only batches not marked inactive)
- Inactive (View only batches marked inactive)
- All (View all loaded batches)

12. Sort By

- Alphabetical
- Date
- Pieces
- Priority (for future use)

13. Sort Direction

- Ascending
- Descending

### **Member Selection Screen**

Access the Member Selection screen from the Batch Selector screen or from the More screen. The Member Selector screen allows the operator to view all the members within the current batch. During normal operation, the first uncut member is loaded for setup. From the Member Selection screen, any member can be selected for setup. Simply press the member to cut, and the setup will be loaded.

Figure 3-33: Member Selection Screen

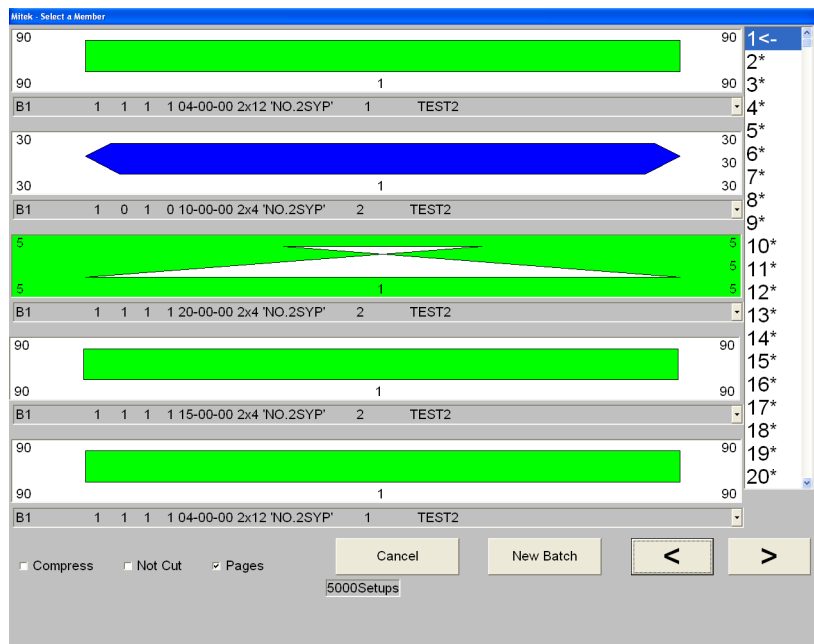

The following color codes are used as a visual reference:

- **Green** - Members in the group are cut.
- **Blue** - Members are currently selected.
- **Red** - Members in the group are not cut.
- **Yellow** - Members in the group are partially cut.

1. CHECK BOXES

- a) COMPRESS - Hides all sub quantities.
- b) NOT CUT - Shows only members not cut.
- c) PAGES - Hides the page number list on the screen.

2. NEW BATCH - Opens the BATCH SELECTOR screen.

3. CANCEL - Exits the Member Selection screen.

## Default Screens



Only authorized maintenance personnel should change default settings.

Incorrect changes can render the saw inoperable.



The calibration key switch on the front of the touch screen enclosure must be set to the ON position to allow changes to default settings.

Several parameters screens allows default parameters to be set. Refer to Figure 3-34 and Figure 3-35 to access the correct screens. The four (4) default screens are:

- Default Parameters screen
- Default Speeds screen
- Advanced Settings screen
- Speed Settings screen

### Default Parameters Screen

**Blade Diameter** - Pressing the corresponding size button changes the blade size. If a blade is removed, the NO BLADE button must be pressed. For each blade that is installed on the saw, a jumper exists in the control panel enabling that blade. If this jumper is not installed, the title for the blade size will read “Blade X Not Installed.”

**Units of Measure** - The IMPERIAL and METRIC buttons toggle the saw between the two units of measure. IMPERIAL measurements are English measurements including feet (ft) and inches (in.). Metric measurements use millimeters (mm) and centimeters (cm).

**Carriage Length** - The carriage length SET button allows the operator to set the maximum cut length. A standard 34-ft saw has a 20-ft maximum cut length. The length is entered in ft-in.-sixteenths for imperial measurements or in cm for metric measurements.

**Home Position** - Indicate if you want a vertically straight saw blade to be considered 0° or 90°. The default is 90° and all instructions that come with the saw assume vertical equals 90°.

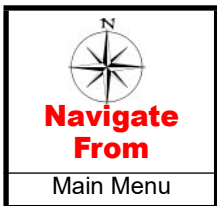

### Default Speeds Screen

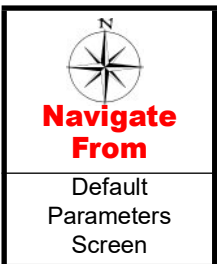

**Infeed Conveyor Maximum Speed** - The 5 & 6 OUT CUT button sets the maximum speed of the infeed conveyor when both blades 5 and 6 are out of the cut. The 5/6 IN CUT button sets the maximum speed of the infeed conveyor when blade 5 or blade 6 is in the cut. Slowing the infeed conveyor when blades 5 and 6 are in the cut will greatly improve the quality of the cut.

**Carriage Speed** - The high speed for the carriage speed default was set at the factory and should not be altered. The HIGH SPEED adjustment sets the maximum speed the

carriage can travel. The low speed can be lowered to allow more accurate stopping of the carriage.

Carriage Brake Advance - The IN and OUT carriage brake advance buttons allow the brake to activate early to help stop the carriage at the set point. The numeric display shows the number of counts away from the default set point that the brake will activate. The factory default is 0 counts.

### Advanced Settings Screen

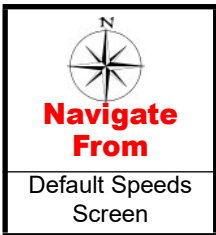

The Advanced Settings screen allows authorized personnel to change passwords, maintain database files, and determine if the overfeed warning should display. A password is required to enter this screen. Document the password in an appropriate place where other authorized personnel can find it because MiTek cannot reset the password if you forget it.

The default for the overfeed warning is ON. It is recommended that you leave it on. Without this warning, there may be confusion if an operator overfeeds the saw.

### Speed Settings Screen

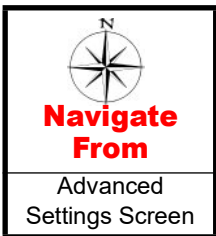

Angle Speeds, Centerline Speeds and Infeed Conveyor Speeds - These components have a medium and a low speed setting that can be adjusted using the Speed Settings screen. These settings affect the speed of that component at different stages in its path. Figure 3-35 shows an example of one of these adjustment screens.



Only minor changes from the default should be made. If the medium speed is set too high, it could damage components. If the low speed is set too low, dirt and debris could prevent the component from moving.

Speed Zone Settings - The SPEED ZONE SETTINGS button allows you to set the point at which a moving component reduces its speed to the low speed. The numbers displayed on the Speed Zone Settings screen are the number of “clicks” remaining until the component reaches its destination. The screen is shown in Figure 3-35.

Figure 3-34: Accessing Screens to Set Default Parameters

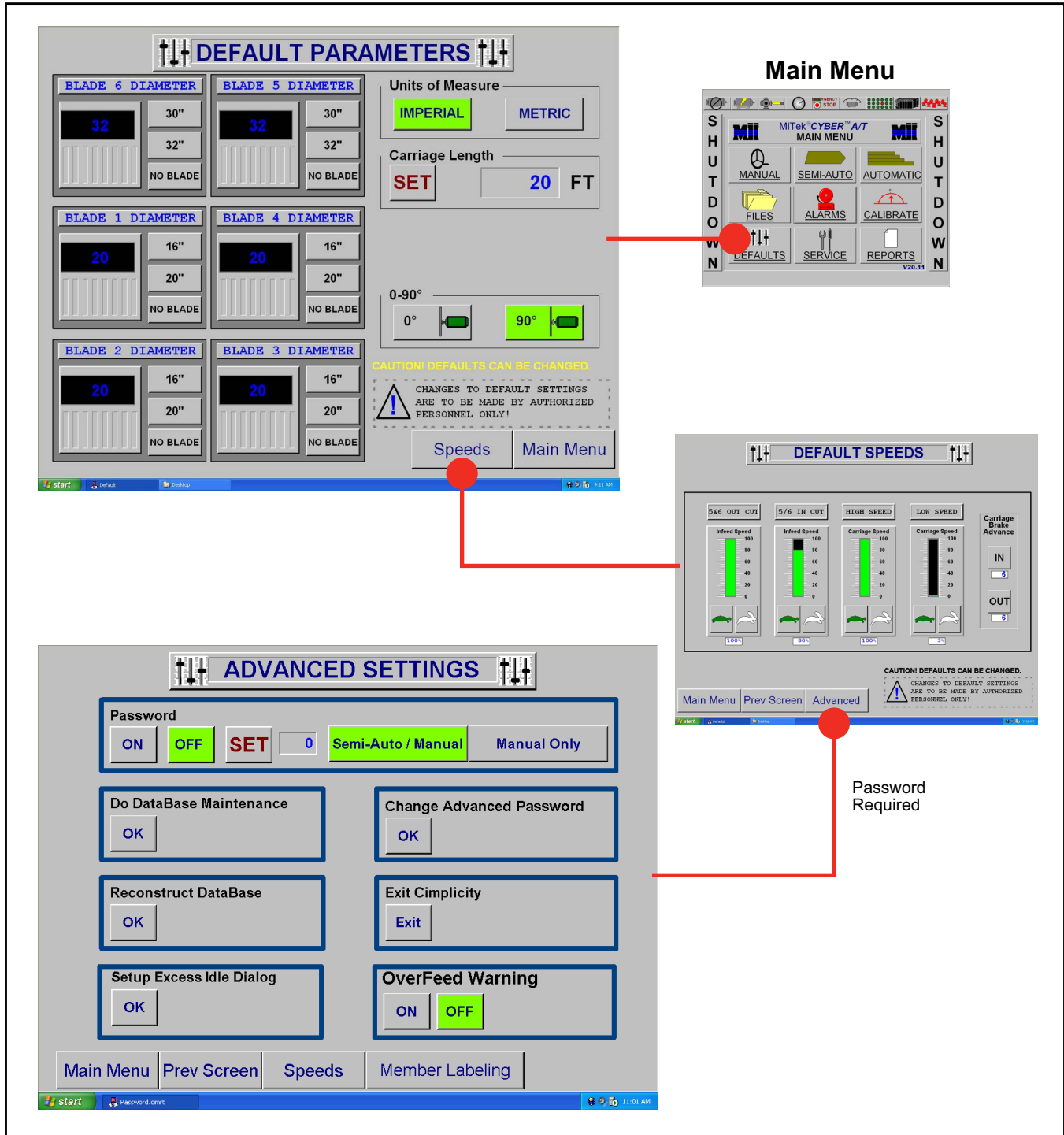
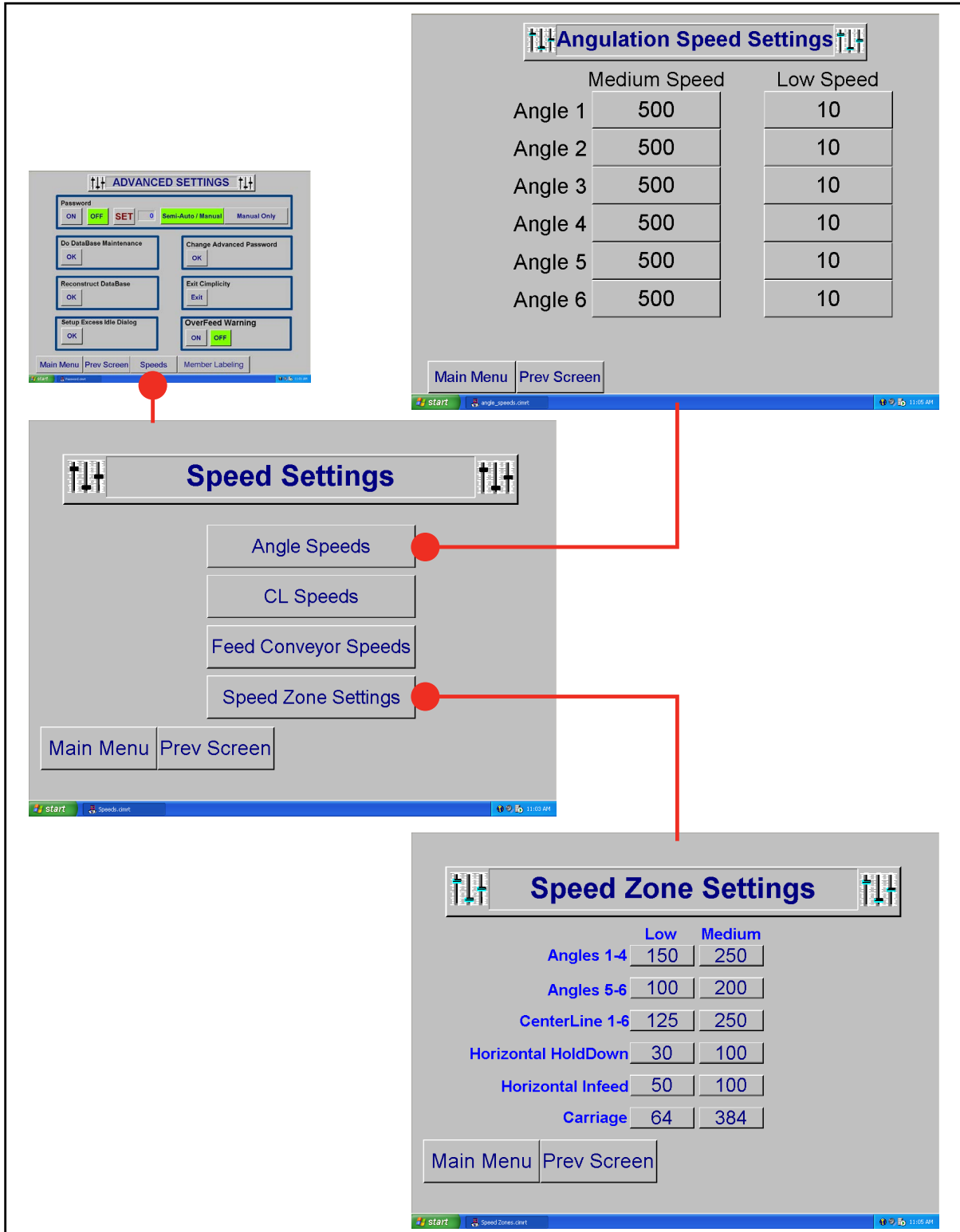

Figure 3-35: Screens Accessed From the Advanced Settings Screen





## Alarm Conditions Menu

Access the Alarm Conditions Menu by pressing the ALARMS button on the Main Menu. You can also access each individual alarm screen by using the Alarms Status Bar at the top of most screens. The alarm screens will guide you to the cause of a fault and inform the operator how to clear the fault.

|   |   |
|---|---|
| <b>WARNING</b>  |   |
|  | <b>Always lockout and tagout the main electrical source before opening the control panel! Severe electrical hazard exists, including death or severe personal injury.</b> |

Figure 3-36: Alarm Conditions Menu



### Main Menu

The MAIN MENU button on the Alarm Conditions Menu screen returns the operator to the Main Menu.

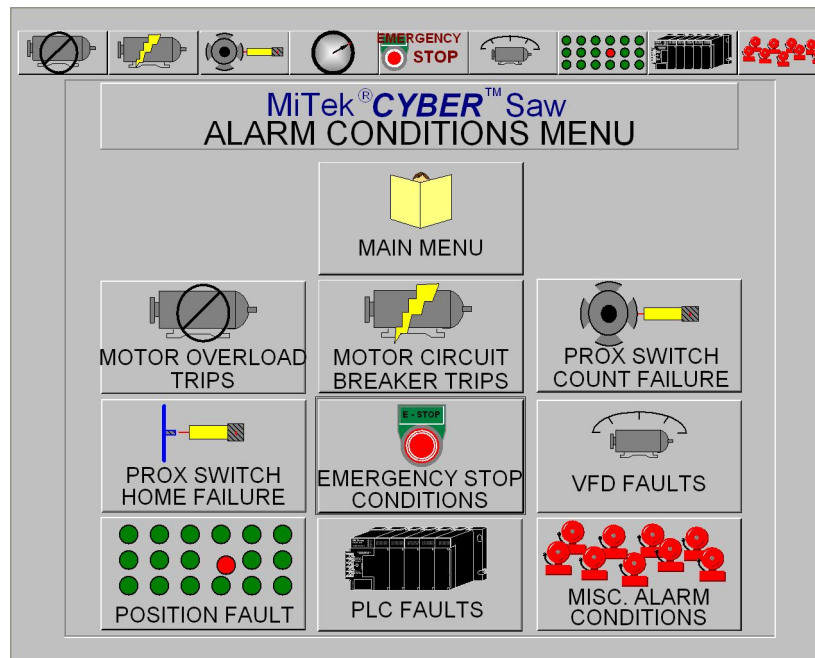
### Motor Thermal Overload Alarms

A motor overload occurs when a motor runs under excessive load and begins to heat up. The motor overload protection will trip before the motor is damaged. The overload protection is mounted to the output side of the motor starter.

Figure 3-37: Motor Thermal Overload Alarms Screen

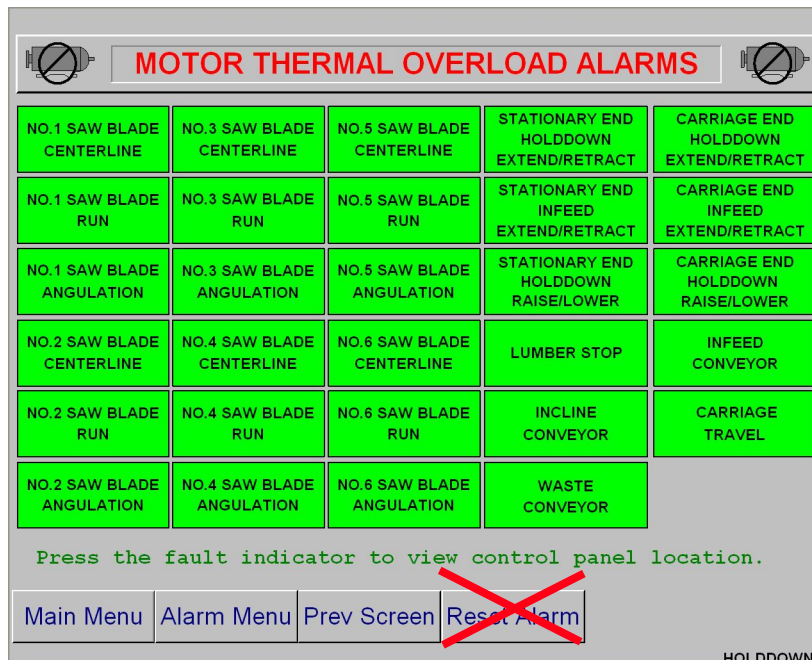

To reset a motor thermal overload:

1. Determine the cause of the overload and correct.
2. Turn off and lockout the main electrical source.
3. Locate the overload inside the electrical enclosure and press the red reset button.
4. Restore power and resume normal operation.

### Motor Circuit Breaker Alarm

A motor breaker trip occurs during a short-circuit condition. The circuit breaker feeds power to the input side of the motor starter.

Figure 3-38: Motor Circuit Breaker Alarms Screen

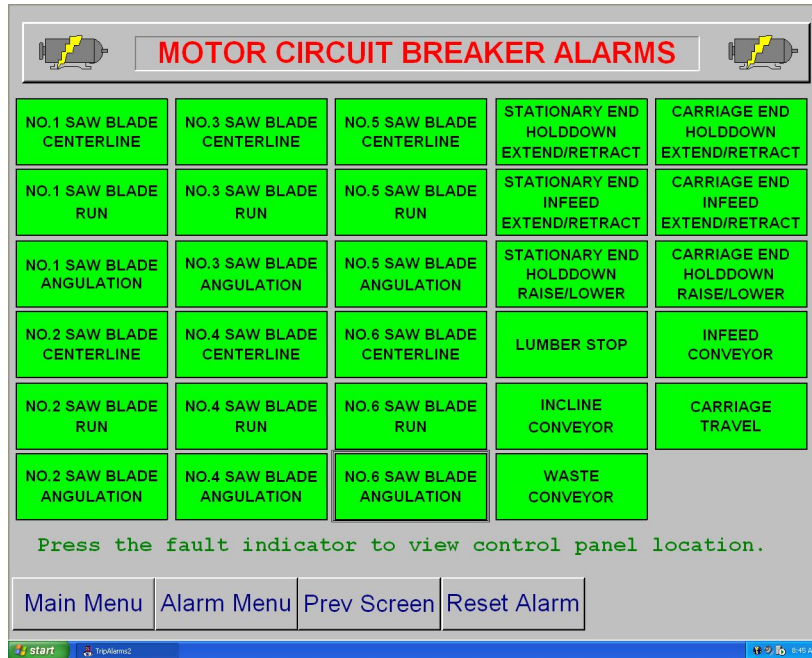

To reset a circuit breaker:

1. Determine the cause of the breaker trip and correct.
2. Turn off and lockout the main electrical source.
3. Locate the breaker and switch it off, then back on (up position).
4. Restore power and resume normal operation.

## Proximity Switch Count Alarms

A proximity (prox) switch count alarm will occur when an axis is moving and no count pulses are detected. The count proximity switch sends pulses to the PLC as a metal cam on the axis drive rotates. The pulses are counted by the PLC to track axis position.

The proximity switch count alarm is caused when the PLC does not receive a signal from the count prox for 1/2 seconds when the axis should be moving.

**Figure 3-39: Proximity Switch Count Failure Screen**

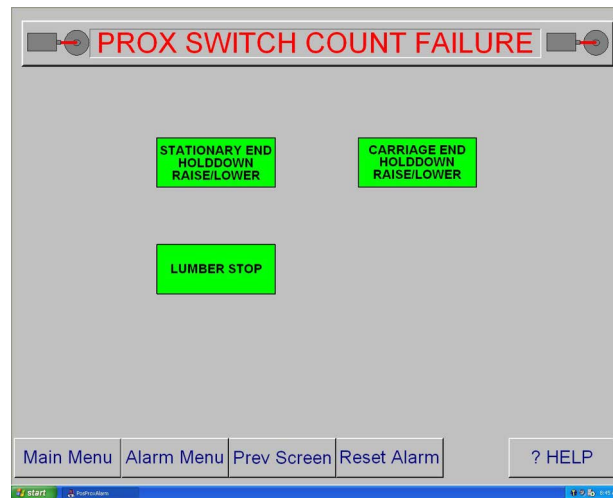

To reset a count alarm:

1. Determine the cause of the alarm and correct.
2. Press the ALARM RESET button on the touch screen.
3. Resume normal operation.

## Home Proximity Switch Alarm

A home proximity (prox) switch fault will occur if an axis is far out of calibration or the home target is not sensed. The axis is calibrated each time the home proximity switch passes a metal target.

**Figure 3-40: Proximity Switch Failure Screen**

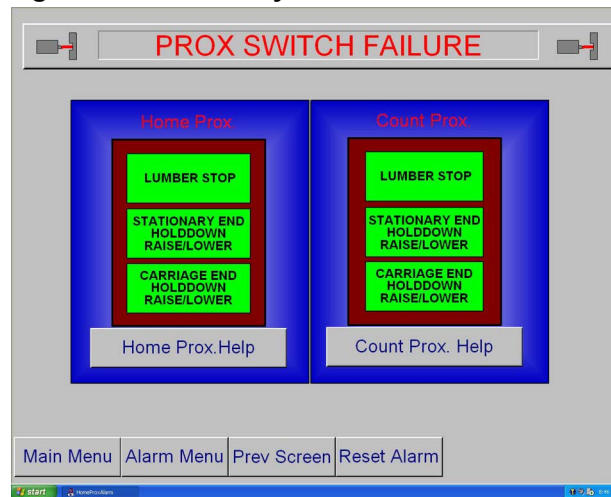

To reset a home alarm:

1. Determine the cause of the alarm and correct.
2. Press the ALARM RESET button on the touch screen.
3. Resume normal operation.

### Profibus Fault

- A red indicator(s) represents a problem with the encoder or Profibus network.
- A yellow indicator(s) represents a count fault.

Figure 3-41: Profibus and Encoder Faults Screen

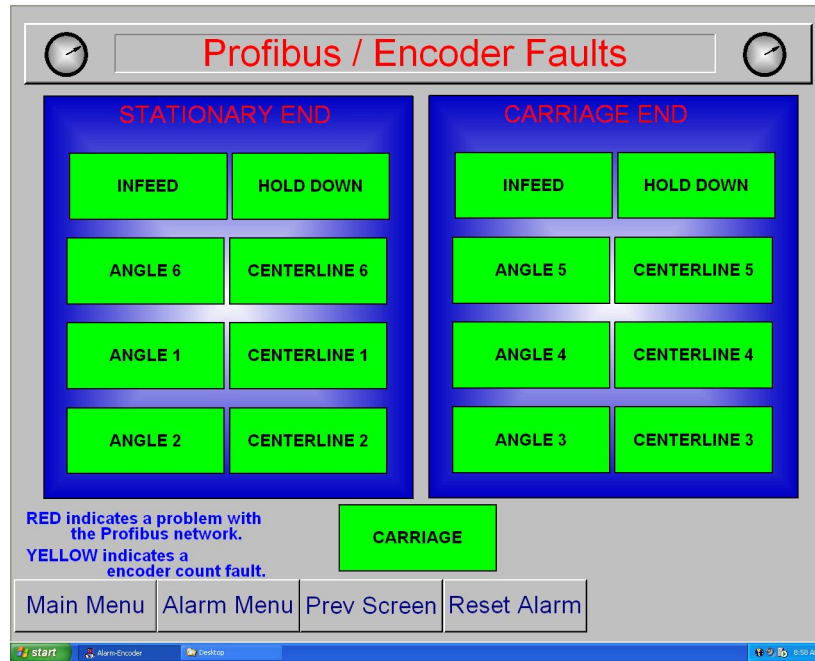

- A red indicator(s) represents a problem with the encoder or Profibus network.
- A yellow indicator(s) represents a count fault. The position did not change when the axis was signaled to move. Correct the problem and reset the alarm by pressing the RESET ALARM button on the screen.

## Emergency Stop Alarm

An emergency stop (E-stop) alarm will occur if any emergency stop pushbutton is pressed, the pull cord (perimeter safety cable) is activated, or low air pressure on the blade motor brakes is sensed.

Figure 3-42: Emergency Stop Status Screen

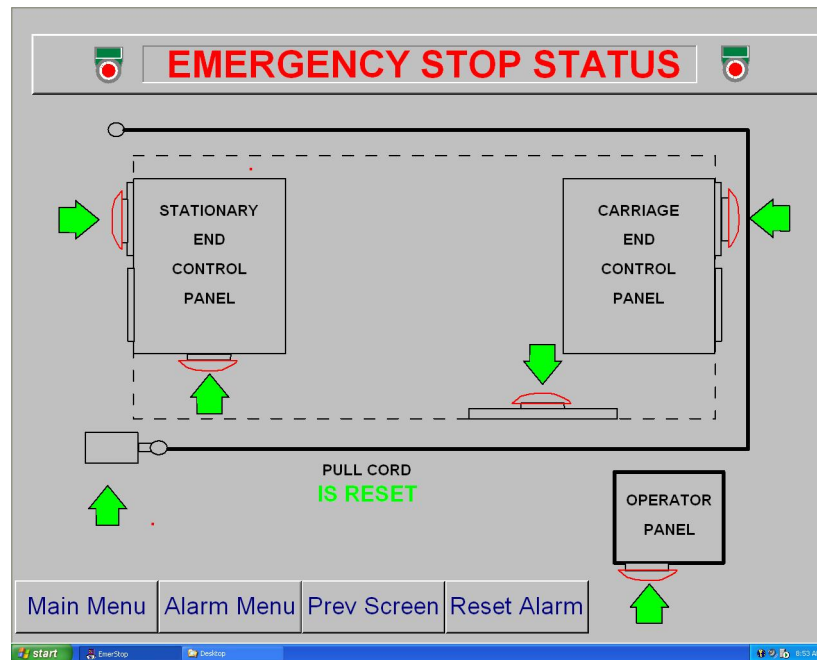

To reset an E-stop:

- Pull out the emergency stop pushbutton that is activated.
- Press the reset button on the perimeter safety cable alarm to reset the perimeter safety cable switch.

### Variable Frequency Drive Alarm

A variable frequency drive (VFD) alarm can be caused by a motor overload, short circuit, under-voltage, and similar conditions. The VFD has built-in diagnostics that check for a variety of problems.

Figure 3-43: VFD Faults Screen

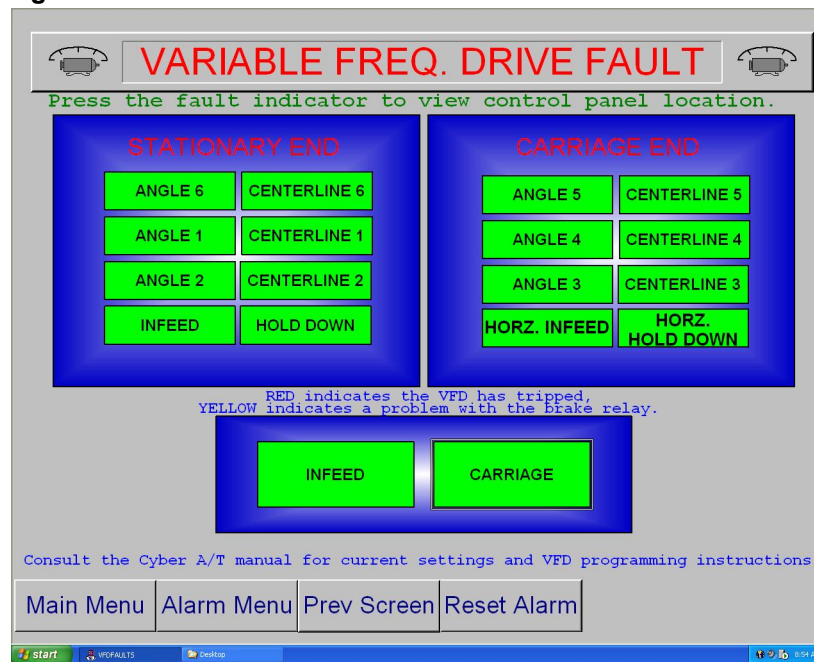

To Reset a VFD:

1. Determine the cause of the fault and correct the problem.
2. Reset the fault using one of these methods:
  - Press the reset button on the VFD
  - Press the RESET ALARM button on the screen.



### Position Alarm

A position alarm will occur during automatic positioning if all axes do not reach their set point within 60 seconds. The Position Alarm screen will indicate which axis failed to reach its set point. The START button will not be available until the saw recognizes all axes are in position.

The most common reason for this fault is a mechanical binding preventing a component from moving. Clean, lubricate, and inspect the saw to determine the cause of a position alarm.

Figure 3-44: Position Fault Screen

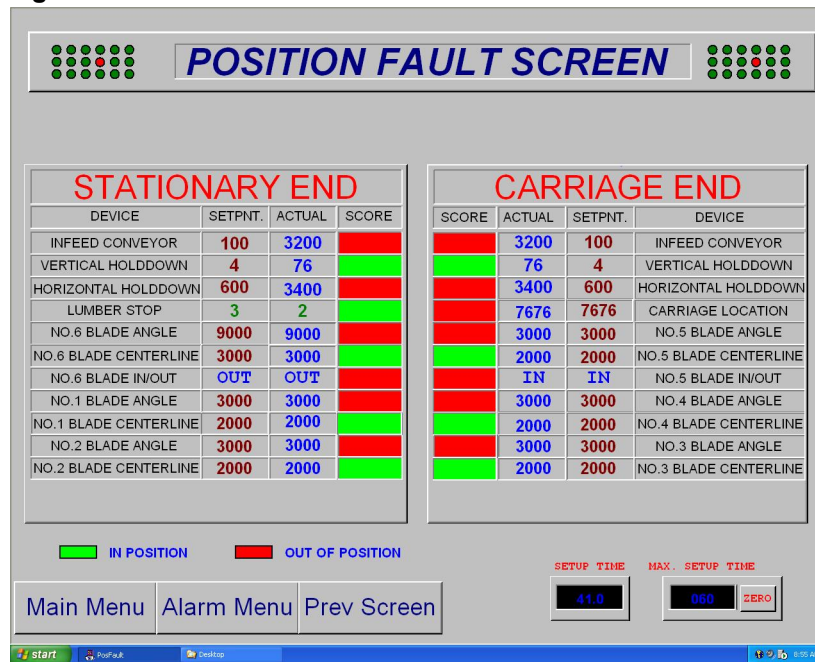

To reset a position alarm:

- a) Determine the cause of the alarm and correct.
- b) Press the INITIATE SETUP button on the Semiauto or Automatic screens to perform setup again.

### Programmable Logic Controller Fault

The programmable logic controller (PLC) has several status points that are monitored to help diagnose PLC-related problems. It is normal for some of these status points to show a fault when the power is turned on.

Figure 3-45: PLC Status Screen

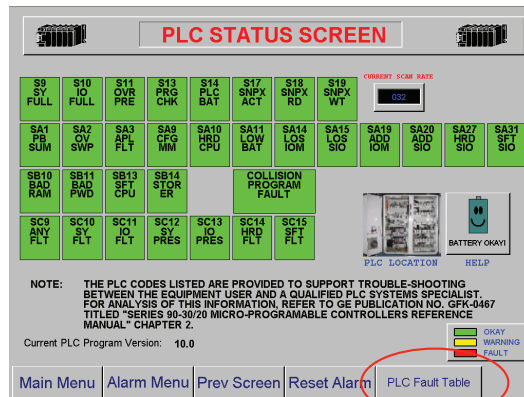

PLC Status shows current PLC status.

PLC Fault Table shows the most recent PLC faults that have occurred.

To reset a PLC alarm:

- a) Determine the cause of the alarm and correct.
- b) Press the ALARM RESET button on the touch screen.
- c) Resume normal operation.

## Miscellaneous Alarms

The Miscellaneous Alarms screen is for alarms that don't fit into the categories discussed on other screens. Each alarm is described here.

**Figure 3-46: Miscellaneous Alarms Screen**

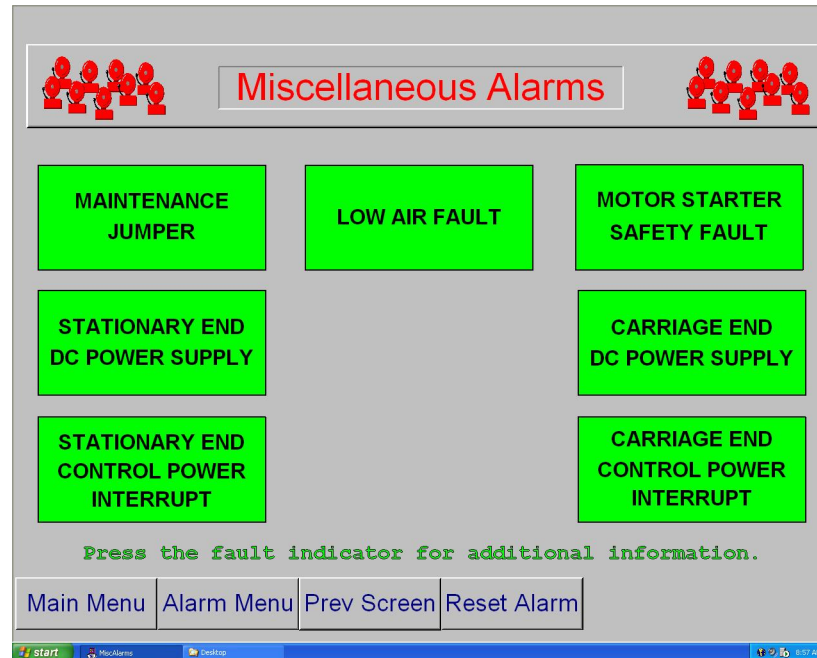

All of the miscellaneous alarms are reset automatically when the alarm condition is cleared.

- Maintenance Jumper - The maintenance jumper indicator will be yellow when the stationary end jumper is not in place. This jumper is used for saw setup and maintenance only. Semiautomatic and automatic operations are not allowed if the jumper is open.
- Stationary-End DC Power Supply Fault - The DC power supplies in the stationary and carriage control panels are monitored. A DC power supply alarm will be displayed when the DC power is off.
- Stationary-End Control Power Interrupt - The AC control power in the stationary and carriage control panels is monitored. A control power alarm will be displayed when the AC power is off.
- Low Air Fault - The low air alarm will occur when the air pressure feeding the saw drops below 60 psi.

- **Motor Starter Safety Fault** - The Motor Starter Safety Fault displays when a motor starter is engaged when it should not be or a motor starter does not engage when it should be.



A motor starter safety fault may occur when a motor starter is on and the PLC program has it turned off. This condition will drop out the emergency stop circuit, causing all motors to turn off. This is monitored to enhance machine safety.

- **Carriage-End DC Power Supply Fault** - The DC power supplies in the stationary and carriage control panels are monitored. A DC power supply alarm will be displayed when the DC power is off.
- **Carriage-End Control Power Interrupt** - The AC control power in the stationary and carriage control panels is monitored. A control power alarm will be displayed when the AC power is off.

## Maintenance Record Screens

Access the Maintenance Record screens by pressing the SERVICE button on the Main Menu.

The Maintenance Record screen 1 and screen 2 allow maintenance records to be viewed. They are used for displaying detailed information about all axes of the saw and predetermining possible trouble spots.

Figure 3-47: Maintenance Record Screens

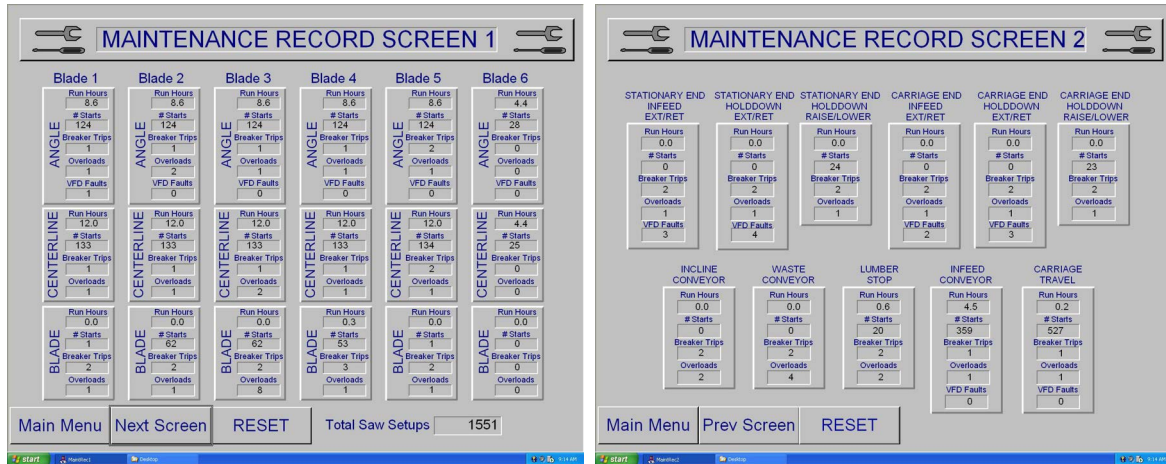

The Maintenance Record Reset screen is used to reset the data on the Maintenance Record screens 1 and 2 back to zero (0). This feature is useful during troubleshooting. The data is not archived, so ensure you will not need it before resetting data.

Figure 3-48: Maintenance Record Reset Screen

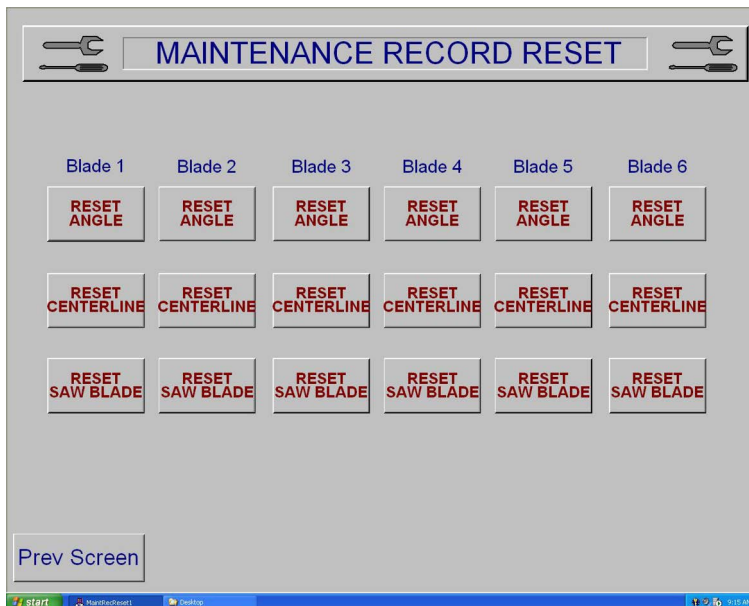

## Reports Screens

The *Cyber A/T* saw tracks productivity and provides basic reports. This information is stored in a *Microsoft<sup>®</sup> Access<sup>®</sup>* database called *cybrdata.mdb* located in 'c:\simplicity\mitek\scripts'.

The first Cyber Stats screen allows statistics to be viewed by day, week to date, and month to date. To view statistics for a past day, simply press the date on the calendar.

Statistics are stored for three (3) days (can be changed in the *Cybersaw.ini* file). Increasing the number of days can cause member load times to increase, since the database will become larger as the number of statistic days is increased.

**Figure 3-49: All 3 Reports Screen**

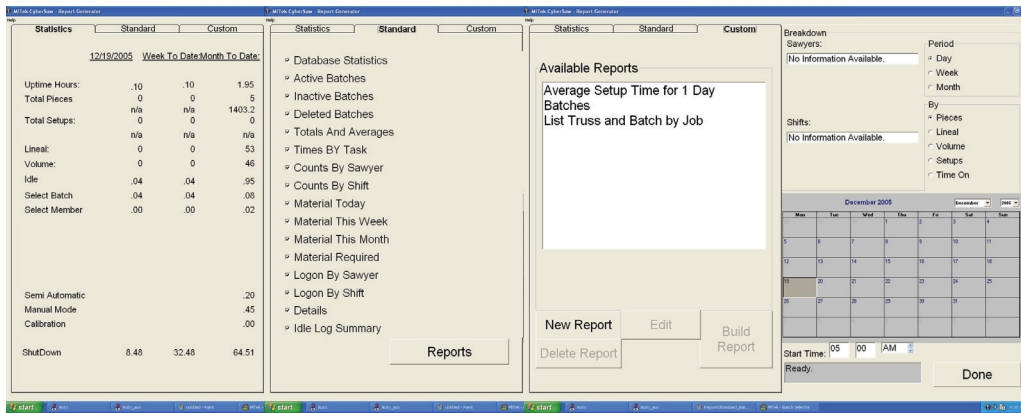

## Calibration Screen

See the *Calibration Check* section starting on page MT-49 in the Maintenance Manual for calibration instructions.



The calibration key switch on the front of the touch screen enclosure must be set to the ON position to allow changes to settings on the Calibration screen.

# Operation Part 4: Sample Cuts



All sample cuts should be done in Semiautomatic Mode.

|                |  |
|----------------|--|
| <b>WARNING</b> |  |
|                | <b>Read and understand all safety precautions before operating this equipment. Failure to do so may result in death or severe personal injury.</b> |

## Sample Cut #1: Bottom Chord



Note that some cutting lists use 0° when the saw blades are vertical.

These saw blades are 90° when the blades are vertical.

Figure 3-50: Saw Blade Positions for Bottom Chord Sample

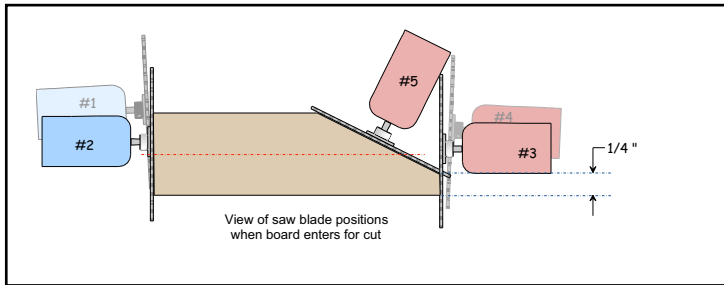
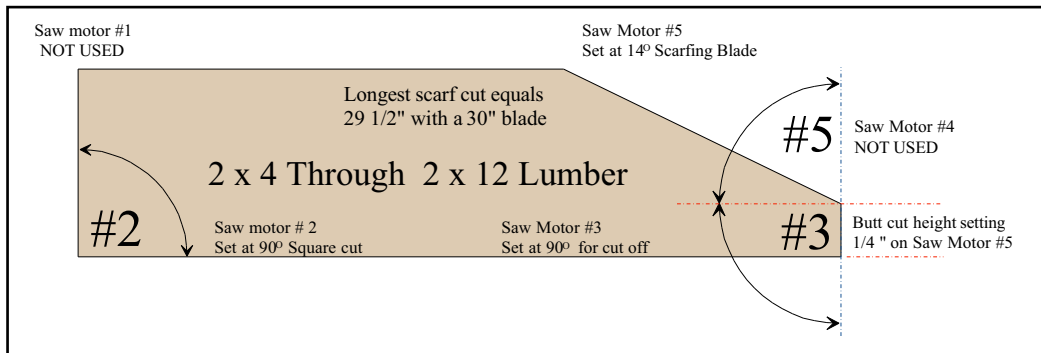

Table 3-5: Specifications for Bottom Chord Sample

|                |  |
|----------------|--|
| Pitch and Span | 3:12 pitch - 24' 8" span - 1/4" heel           |
| Lumber Size    | 2x4  |
| Attachments    | Heel cut skid bar (see page OP-60 for details) |

Figure 3-51: Bottom Chord Diagram



1. Turn the power on.
2. Angle blade 1 to 90° (Enter 900).  
Raise centerline above lumber width if an angle other than 90° was entered.
3. Angle blade 2 to 90° (Enter 900). Set the centerline to 1-3/4 in. by entering 112.
4. Angle blade 3 to 90° (Enter 900). Set the centerline to 1-3/4 in. by entering 112.
5. Angle blade 4 to 90° (Enter 900). If an angle other than 90° is entered, raise the centerline above lumber width.
6. Angle blade 5 to 14° (Enter 140). Position the centerline at the required butt cut height.
7. Set the carriage length at 12 ft 4 in. (Enter 12 04 00).
8. Set the infeed speed to middle setting.
9. Set the lumber stop at 1/2-in. mark to the left of “0” on scale.
10. Position the heel cut skid bar approximately 2 in. from the blades, between blades and feed chain, and lock it in place. This is not required unless the infeed offset is greater than 6 inches.
11. Set both the vertical height of both hold-downs to the 2x4 setting on the scales.
12. Position center lumber support approximately midway between infeed chains.
13. Place 2x4 on edge in the feed conveyor at the root of the lumber pivot arm and push it against the lumber stop.
14. Press the START button on the touch screen.
15. After the board is cut, check all dimensions on the board for accuracy.
16. Repeat as necessary.



## Sample Cut #2: Top Chord



Note that some cutting lists use 0° when the saw blades are vertical.

These saw blades are 90° when the blades are vertical.

**Figure 3-52: Saw Blade Positions for Top Chord Sample**

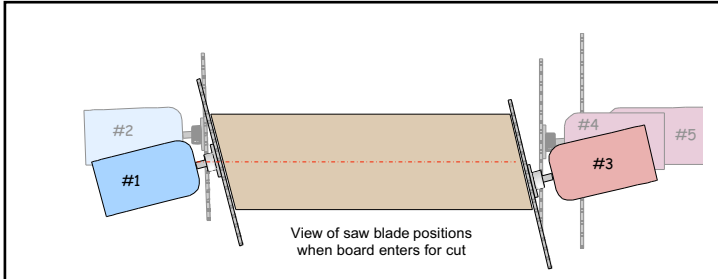

**Table 3-6: Specifications for Top Chord Sample**

|                |  |
|----------------|--|
| Pitch and Span | 3:12 pitch - 24' 8" span                           |
| Lumber Size    | 2x4  |
| Attachments    | Center lumber support (see page OP-60 for details) |

**Figure 3-53: Top Chord Diagram**

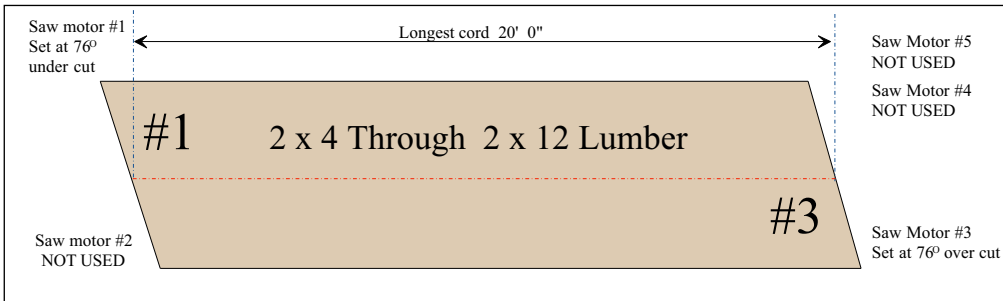

1. Turn the power on.
2. Angle blade 1 to 76°. (Enter 760).
3. Angle blade 2 to 90° (Enter 900).

The centerline can be placed at any height.

4. Angle blade 3 to 76°. (Enter 760).
5. Angle blade 4 to 90° (Enter 900).

The centerline can be placed at any height.

6. Use the OUT OF CUT button on saw #5.
7. Set the carriage to the overall length of the top chord.

8. Set the centerline on blade 3 to 0 inch and #1 saw to board height.
9. Set the infeed speed to middle setting.
10. Set the lumber stop at the 1/2 in. mark to the left of “0” on scale.
11. Set the vertical height for both hold-downs to the 2x4 setting on the scales.
12. Position the center lumber support approximately midway between chain.
13. Place 2x4 on edge on the infeed conveyor at the root of the lumber pivot arm, and push it against the lumber stop.
14. Press the START button on touch screen.
15. After the board is cut, check all dimensions on the board for accuracy.
16. Repeat as needed.

## Sample Cut #3: Roof Truss Web



Note that some cutting lists use 0° when the saw blades are vertical.

These saw blades are 90° when the blades are vertical.

Figure 3-54: Saw Blade Positions for Web Sample

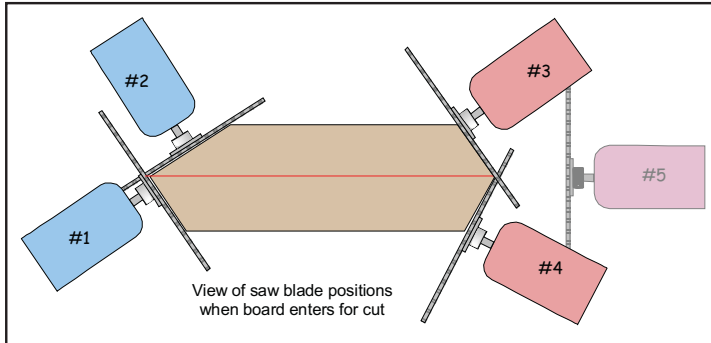
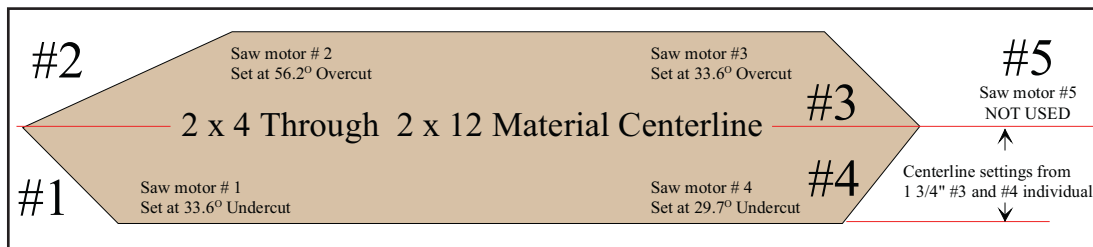

Table 3-7: Specifications for Web Sample

|                |                                      |
|----------------|--------------------------------------|
| Pitch and Span | 3:12 pitch - 24' 8" span - 1/4" heel |
| Lumber Size    | 2x4                                  |
| Attachments    | none                                 |

Figure 3-55: Web Diagram



1. Turn the power on.
2. Angle blade 1 to 33.6° (Enter 336).
3. Angle blade 2 to 56.2° (Enter 562).
4. Angle blade 3 to 33.6° (Enter 336).
5. Angle blade 4 to 29.7° (Enter 297).
6. Set blade 5 to out-of-cut.
7. Set the carriage to the overall length of the web.
8. Set the centerline of all four saws to 1-3/4 in.
9. Set the infeed speed to the middle setting.

10. Set the lumber stop at the 1/2 in. mark to the left of “0” on scale.
11. Set the vertical height of both hold-downs to the 2x4 setting on the scales.
12. Position the center lumber support approximately midway between chain.
13. Place the 2x4 on edge on the infeed conveyor at the root of the lumber pivot arm, and push it against the lumber stop.
14. Press the START button on the touch screen.
15. After the cut, check all dimensions on the board for accuracy.
16. Repeat as needed.

## Sample Cut #4: Floor Truss Web



Note that some cutting lists use 0° when the saw blades are vertical.

These saw blades are 90° when the blades are vertical.

**Figure 3-56: Saw Blade Positions for Floor Truss Web**

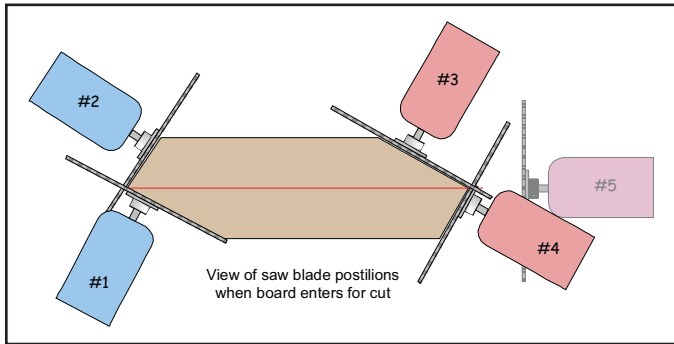

**Table 3-8: Specifications for Floor Truss Web**

|                |   |
|----------------|---|
| Pitch and Span | 3:16 pitch - 24' 8" span                                    |
| Lumber Size    | 2x4   |
| Attachments    | Floor truss web riser bars.<br>(see page OP-61 for details) |

**Figure 3-57: Floor Truss Web Diagram**

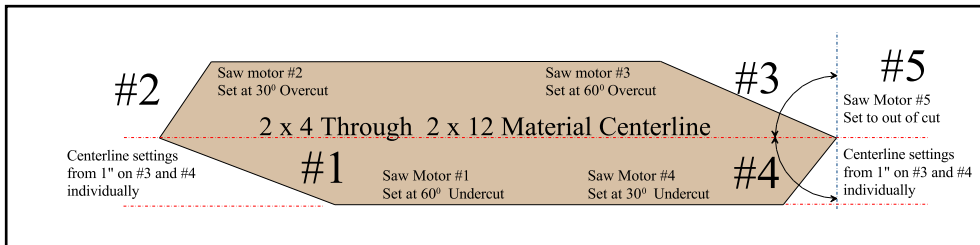

1. Turn the power on.
2. Angulate blade 1 to 60° (Enter 600).
3. Angulate blade 2 to 30° (Enter 300).
4. Angulate blade 3 to 60° (Enter 600).
5. Angulate blade 4 to 30° (Enter 300).
6. Set blade 5 to out-of-cut.
7. Set the carriage length at 2 ft 2 in.
8. Set the centerline for all four saws to 15/16 in.
9. Set the infeed speed to middle setting.

10. Set the lumber stop at 1/2 in. mark to the left of “0” on scale.
11. Set the vertical height of both hold-downs to the 2x4 setting on the scales.
12. Place the 4x2 on edge on the infeed conveyor at the root of the lumber pivot arm, and push it against the lumber stop.
13. Press the START button on the touch screen.
14. After the cut, check all dimensions on the board for accuracy.
15. Repeat as necessary.

## Sample Cut #5: Scissors Bottom Chord



Note that some cutting lists use 0° when the saw blades are vertical.

These saw blades are 90° when the blades are vertical.

Figure 3-58: Saw Blade Positions for Scissors Bottom Chord Sample Cut

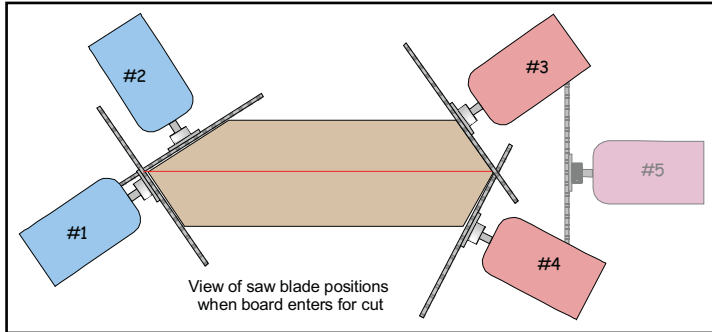
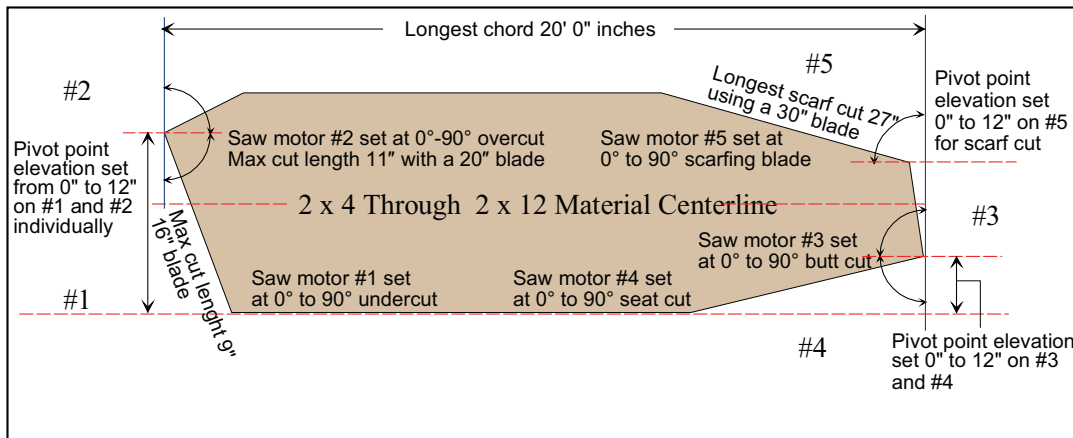

Table 3-9: Scissors Bottom Chord Specifications

|                |   |
|----------------|---|
| Pitch and Span | 3:12 pitch - 24' 8" span                          |
| Lumber Size    | 2x6   |
| Attachments    | Heel cut skid bar<br>(see page OP-60 for details) |

Figure 3-59: Specifications for Scissors Bottom Chord Sample Cut



1. Turn the power on.
2. Angle blade 1 to 71.5° (Enter 715).
3. Angle blade 3 to 71.5° (Enter 715).
4. Angle blade 4 to 18.3° (Enter 183).
5. Angle blade 5 to 15.3° (Enter 153).
6. Set the carriage to the overall length of the board.

7. Set the centerlines for blades 1 and 2 to 4-1/2 in. (Enter 408).
8. Set centerlines for blades 3 and 4 to 1-7/8 in. (Enter 114).
9. Set blade 5 centerline to 3-3/4 in. (Enter 212).
10. Set the infeed speed to the middle setting.
11. Set the lumber stop at the 1/2 in. mark to the left of “0” on scale.
12. Set the vertical height of both hold-downs to the 2x6 setting on the scales.
13. Position the center lumber support approximately midway between chain.
14. Place the 2x6 on edge on the infeed conveyor at the root of the lumber pivot arm, and push it against the lumber stop.
15. Press the START button on the touch screen.
16. After the cut, check all dimensions on the board for accuracy.
17. Repeat as needed.



## Operation Part 5: Angle and Slope Conversion Chart

Table 3-10 shows what the slope of a cut will be when the saw blade is set at the angle indicated.

If the cut should be a 4/12 slope, look for 4" in the yellow columns. The blade angle should be set at 18.4° to accomplish a 4/12 slope.

Table 3-10: Saw Blade Angles Required for Specific Slopes

| Deg.<br>° | In.<br>" | Deg.<br>° | In.<br>" | Deg.<br>° | In.<br>" | Deg.<br>° | In.<br>" | Deg.<br>° | In.<br>" | Deg.<br>° | In.<br>" |
|-----------|----------|-----------|----------|-----------|----------|-----------|----------|-----------|----------|-----------|----------|
| 0         | 0        | 9.5       | 2        | 18.4      | 4        | 26.6      | 6        | 33.8      | 8        | 39.8      | 10       |
| 0.3       | 1/16     | 9.8       | 2-1/16   | 18.7      | 4-1/16   | 26.8      | 6-1/16   | 33.9      | 8-1/16   | 40.0      | 10-1/16  |
| 0.9       | 3/16     | 10.3      | 2-3/16   | 19.2      | 4-3/16   | 27.3      | 6-3/16   | 34.3      | 8-3/16   | 40.3      | 10-3/16  |
| 1.1       | 1/4      | 10.6      | 2-1/4    | 19.5      | 4-1/4    | 27.5      | 6-1/4    | 34.5      | 8-1/4    | 40.5      | 10-1/4   |
| 1.5       | 5/16     | 10.9      | 2-5/16   | 19.8      | 4-5/16   | 27.8      | 6-5/16   | 34.7      | 8-5/16   | 40.7      | 10-5/16  |
| 1.8       | 3/8      | 11.2      | 2-3/8    | 20.0      | 4-3/8    | 28.0      | 6-3/8    | 34.9      | 8-3/8    | 40.9      | 10-3/8   |
| 2.1       | 7/16     | 11.5      | 2-7/16   | 20.3      | 4-7/16   | 28.2      | 6-7/16   | 35.1      | 8-7/16   | 41.0      | 10-7/16  |
| 2.4       | 1/2      | 11.8      | 2-1/2    | 20.6      | 4-1/2    | 28.4      | 6-1/2    | 35.3      | 8-1/2    | 41.2      | 10-1/2   |
| 2.7       | 9/16     | 12.1      | 2-9/16   | 20.8      | 4-9/16   | 28.7      | 6-9/16   | 35.5      | 8-9/16   | 41.4      | 10-9/16  |
| 3.0       | 5/8      | 12.3      | 2-5/8    | 21.1      | 4-5/8    | 28.9      | 6-5/8    | 35.8      | 8-5/8    | 41.5      | 10-5/8   |
| 3.3       | 11/16    | 12.6      | 2-11/16  | 21.3      | 4-11/16  | 29.1      | 6-11/16  | 35.9      | 8-11/16  | 41.7      | 10-11/16 |
| 3.6       | 3/4      | 12.9      | 2-3/4    | 21.6      | 4-3/4    | 29.4      | 6-3/4    | 36.1      | 8-3/4    | 41.9      | 10-3/4   |
| 3.9       | 13/16    | 13.1      | 2-13/16  | 21.9      | 4-13/16  | 29.6      | 6-13/16  | 36.3      | 8-13/16  | 42.0      | 10-13/16 |
| 4.2       | 7/8      | 13.5      | 2-7/8    | 22.1      | 4-7/8    | 29.8      | 6-7/8    | 36.5      | 8-7/8    | 42.2      | 10-7/8   |
| 4.5       | 15/16    | 13.8      | 2-15/16  | 22.4      | 4-15/16  | 30.0      | 6-15/16  | 36.7      | 8-15/16  | 42.3      | 10-15/16 |
| 4.8       | 1        | 14.0      | 3        | 22.6      | 5        | 30.3      | 7        | 36.9      | 9        | 42.5      | 11       |
| 5.1       | 1-1/16   | 14.3      | 3-1/16   | 22.9      | 5-1/16   | 30.5      | 7-1/16   | 37.1      | 9-1/16   | 42.7      | 11-1/16  |
| 5.4       | 1-1/8    | 14.6      | 3-1/8    | 23.1      | 5-1/8    | 30.7      | 7-1/8    | 37.2      | 9-1/8    | 42.8      | 11-1/8   |
| 5.7       | 1-3/16   | 14.9      | 3-3/16   | 23.4      | 5-3/16   | 30.9      | 7-3/16   | 37.4      | 9-3/16   | 43.0      | 11-3/16  |
| 6.0       | 1-1/4    | 15.2      | 3-1/4    | 23.6      | 5-1/4    | 31.1      | 7-1/4    | 37.6      | 9-1/4    | 43.2      | 11-1/4   |
| 6.2       | 1-5/16   | 15.4      | 3-5/16   | 23.9      | 5-5/16   | 31.4      | 7-5/16   | 37.8      | 9-5/16   | 43.3      | 11-5/16  |
| 6.5       | 1-3/8    | 15.7      | 3-3/8    | 24.1      | 5-3/8    | 31.6      | 7-3/8    | 38.0      | 9-3/8    | 43.5      | 11-3/8   |
| 6.8       | 1-7/16   | 16.0      | 3-7/16   | 24.4      | 5-7/16   | 31.8      | 7-7/16   | 38.2      | 9-7/16   | 43.6      | 11-7/16  |
| 7.1       | 1-1/2    | 16.3      | 3-1/2    | 24.6      | 5-1/2    | 32.0      | 7-1/2    | 38.4      | 9-1/2    | 43.8      | 11-1/2   |
| 7.4       | 1-9/16   | 16.5      | 3-9/16   | 24.9      | 5-9/16   | 32.2      | 7-9/16   | 38.6      | 9-9/16   | 43.9      | 11-9/16  |
| 7.7       | 1-5/8    | 16.8      | 3-5/8    | 25.1      | 5-5/8    | 32.4      | 7-5/8    | 38.7      | 9-5/8    | 44.1      | 11-5/8   |
| 8.0       | 1-11/16  | 17.1      | 3-11/16  | 25.4      | 5-11/16  | 32.6      | 7-11/16  | 38.9      | 9-11/16  | 44.2      | 11-11/16 |
| 8.3       | 1-3/4    | 17.4      | 3-3/4    | 25.6      | 5-3/4    | 32.9      | 7-3/4    | 39.1      | 9-3/4    | 44.4      | 11-3/4   |
| 8.6       | 1-13/16  | 17.6      | 3-13/16  | 25.8      | 5-13/16  | 33.1      | 7-13/16  | 39.3      | 9-13/16  | 44.5      | 11-13/16 |
| 8.9       | 1-7/8    | 17.9      | 3-7/8    | 26.1      | 5-7/8    | 33.3      | 7-7/8    | 39.5      | 9-7/8    | 44.7      | 11-7/8   |
| 9.2       | 1-15/16  | 18.2      | 3-15/16  | 26.3      | 5-15/16  | 33.5      | 7-15/16  | 39.6      | 9-15/16  | 44.9      | 11-15/16 |

Deg. = Saw Angles

In. = Slope (x/12)

# Index

## A

- air pressure, minimum 53
- alarm
  - conditions menu 97
  - E-stop 103
  - home proximity switch 101
  - miscellaneous 107
  - motor
    - circuit breaker 99
    - thermal overload 98
  - PLC faults 106
  - position 105
  - Profibus 102
  - proximity switch count 100
  - resetting 69
  - status bar 76, 78
  - VFD 104
- angles
  - adjusting 70
  - conversion chart 121
  - speed 94

## B

- batch cutting files 57
- blades
  - checking 13
  - numbers 43
  - removing from cut 73
  - returning to cut 73
  - specifications 38
  - starting 69
- bottom chord cut 111
- brakes
  - inspecting 13
  - test 14

## C

- calibration 110
- carriage
  - adjusting 72

- control power interrupt 108
- DC power supply fault 108
- length 51, 93
- Catcher Display 69
- caution logo 2
- center lumber support 59
- centerlines
  - adjusting 70
  - speed 94
- circuit breakers 99
- cleaning positions 85
- components
  - features, of saw 36
  - options 37
- computer
  - deleting files 57
  - loading files 57
  - PC enclosure 55, 75
  - shutting down 75
  - software
    - Cimplicity 47
    - CyberSort 47
    - Job Summary 47
    - MBA 47
    - MVP 47
    - PLC 47
    - Project 47
    - screens 76
    - selecting language 69
    - Windows 42
  - turning on 53
- control power interrupt 107, 108
- conveyor
  - incline 52, 63, 80, 84, 89
  - infeed 58, 71, 80, 84
  - waste 89
- Customer Service 34

## D

- danger logos 2
- disconnect switch 45, 74
- drawing set, part number 33

# Index

## E

- electrical enclosure, indicator lights 46
- emergency stops, *see* E-stops
- enclosure
  - PC 55, 75
  - touch screen 53, 75
- encoders 102
- environmental logo 2
- E-stop
  - alarm 103
  - clearing 56
  - location 44
  - overview 44
  - perimeter safety cable 45
  - pushbuttons 45
  - swing guard actuator 45
  - testing 12

## F

- fault
  - clearing 56, 69
  - DC power supply 107, 108
  - low air 107
  - motor starter safety 108
  - PLC 106
  - position 105
  - Profibus 102
  - VFD 104
- features, of saw 36
- feeding lumber 66
- floor truss web cut 117
- floor truss web riser bars 61

## G

- guards
  - checking 14
  - swing E-stop actuator 45

## H

- hazard indicator 2
- heel cut skid bar 60
- hold-downs, adjusting 71

## I

- incline conveyor 52, 63, 80, 84, 89
- indicator lights 46
- infeed conveyor
  - adjusting
    - position 71
    - speed 73
  - offset 58, 68
  - operation 66, 80, 84
  - speed 93, 94
- Inker 37, 69
- installation
  - manual 33

## J

- jumper 93, 107

## L

- lockout/tagout
  - disconnect switches 45
  - guidelines 5
  - procedure 6, 8, 21, 23
- lumber
  - changing size 72
  - direction 64
  - feeding 65
  - removing 67
- lumber stop 72, 80, 85, 89

# Index

## M

- maintenance
  - jumper 107
  - Manual 33
  - performing 56
  - record screen 109
- manual
  - how to use 33
  - introduction 31
  - navigation 32
  - purpose 31
  - understanding formatting 33
- motors
  - alarm
    - circuit breaker 99
    - thermal overload 98
  - starting 85

## N

- notice logo 2
- notice of change iii

## O

- off-feed 67
- one-enclosure system
  - indicator lights 46
- operation
  - adjustments 70
  - choosing
    - batch 68
    - member 68
  - control interface 46
  - feeding lumber 64, 65
  - indicator lights 46
  - lumber direction 64
  - Manual 33
  - manual mode 52
  - miscellaneous 68
  - overview 48
  - removing lumber 64, 67

- safety check 56
- sample cuts 111, 121
- sawing 63
- semiautomatic mode 52
- setup 57
- software 76
- startup 53
- stopping 74
- supports 59
- options 37
- overfeeding 74

## P

- page change iii
- patents ii
- perimeter safety cable 45
- PLC
  - fault 106
  - software 47
  - status 106
- position fault 105
- Profibus fault 102
- programmable logic controller, *see* PLC
- proximity switch
  - count alarm 100
  - home alarm 101
- pull-cord 45

## Q

- quickstart 48

## R

- restricted zones 10, 26
- return goods ii
- roof truss web cut 115

# Index

## S

- safety
  - lockout/tagout 5, 32
  - restricted zones 10, 26
  - safety indicators 2
  - safety rules 2, 16
  - tests 12, 43
- sample cuts
  - bottom chord 111
  - floor truss web cut 117
  - roof truss web 115
  - scissors bottom chord 119
  - top chord 113
- saw blades, *see* blades
- scissors bottom chord cut 119
- scrap conveyor, *see* waste conveyor
- screen
  - manual, using 51
  - semiauto, using 51
- slope conversion chart 121
- software screens
  - alarm conditions menu 97
  - alarm status bar 78
  - automatic 87
  - batch selector 90
  - calibration 110
  - default 93
  - main menu 76
  - maintenance record 109
  - manual 79
  - member selection 91
  - more 89
  - reports 110
  - semiautomatic 83
- specifications
  - features, of saw 36
  - general 38
- stop motion 74
- switches
  - disconnect 45
  - proximity 100

## T

- take-away conveyor, *see* waste conveyor
- top chord cut 113
- touch screen 53, 75
- truss terminology 39
- two-enclosure system, indicator lights 46

## V

- VFD (variable frequency drive) 104

## W

- warning logo 2
- waste conveyor 89

**Cyber® A/T**

**Component Cutting Saw  
Installation Manual**



001055  
Rev. D  
3 of 3

**Cyber® A/T**

**Component Cutting Saw  
Maintenance Manual**



001055  
Rev. D  
2 of 3

**Cyber® A/T**

**Component Cutting Saw  
Operation Manual**



001055  
Rev. D  
1 of 3