

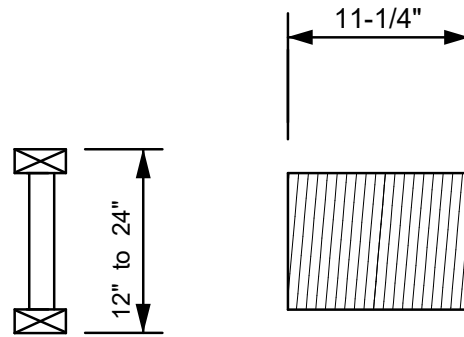

SEE THE MiTek TRUSS DESIGN  
REFERENCING THIS DETAIL  
FOR ADDITIONAL DESIGN INFORMATION

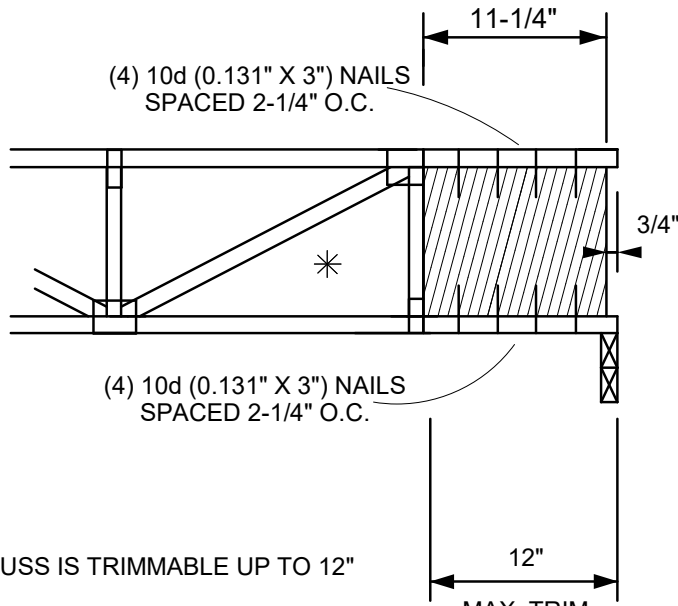

2x12 VERTICAL BLOCK  
No.2 or Better: SPF, SP, DF or HF

TRUSS IS TRIMMABLE UP TO 12"  
MAXIMUM REACTION= 1200 lbs  
MINIMUM BEARING SIZE IS 1-3/4"

\* LAST DIAGONAL WEB MUST BE RAN UP TO THE TOP CHORD AS SHOWN