

---

# MiTek<sup>®</sup>

# SERVICE BULLETIN

---

Document ID:  
**SB266**

Title:  
**Interlock Door Safety Switch Update**

Affected machinery: BLADE II saw

Distribution: All customers with affected machinery (**Installed by MiTek Technician**)

Applies to: All machines built from frame 488 to frame 545.

---

**CAUTION:**

MiTek recommends printing this document in high resolution using color ink. Many of the graphics may be unclear and may create an unsafe condition if this recommendation is not followed.

MiTek Automation  
Phone: 800-523-3380  
Fax: 636-328-9218  
www.mitek-us.com

Part # and Rev.	SB266
Print Date	31 July 2024
Effectivity	Frames 488-545
Revision Date	
Revised By	
Orig. Release Date	30 May 2024
Created By	A. McIntire
Approved By	

## Purpose and Scope

This service bulletin instructs how to update the electrical system of the BLADE II saw to improve the fault recovery process for the safety switches on the interlock doors. Post update, operators will be able to hit the RESET button on the operator interface to clear potential safety switch related faults.

**NOTE:** The Banner safety controller configuration program and config file (92277-503.xsc) must both be downloaded onto your MiTek laptop in order to complete these instructions. The following links will take to the network drive locations where the files are stored. **YOU MUST BE LOGGED INTO THE VPN FOR ACCESS.**

Banner Configuration Program:

[\\ent.mitekindustries.com\Location\FountainLakes\Machinery\ENG\Machinery\Software\Banner Safety Controller XS26\Revision 5\\_3](\\ent.mitekindustries.com\Location\FountainLakes\Machinery\ENG\Machinery\Software\Banner Safety Controller XS26\Revision 5_3)

Configuration File:

<\\ent.mitekindustries.com\Location\FountainLakes\Machinery\ENG\Machinery\Software\PLC-ARC\P0079 Blade Saw Gen2\Safety Controller>

## Overview

### Parts Included

The parts included in this kit are shown in [Table 1](#). Please make sure all parts and supplies are present before starting the procedure.

Table 1: Parts in SB266KIT

Quantity	Description	Part #
3	Terminal blocks	518233
1	Terminal block jumper	518143
1	Terminal block end	518234
3	Relays	514192
1	DIN rail end stop	518192
3	Wago splicer 2-conductor	504010
50 ft	Blue wire 16g	508006-06
15 ft	White/blue wire 16g	508006-10
1 sheet	Labels, blank write-in	694060
1	Service bulletin document	SB266

If you have any questions, call MiTek Automation Support at 1-800-523-3380.





## Supplies Needed

- Wire cutter/stripper
- Flathead or terminal block screwdriver
- USB cable (type A to micro)
- Laptop with Banner safety controller program and config file (92277-503.xsc). See [Purpose and Scope on page 2](#) for links to files.

## Lockout/Tagout Instructions

### Electrical Lockout/Tagout Procedure

The lockout/tagout instructions for the electrical and pneumatic systems will be referenced as necessary in this service bulletin (see [Procedure on page 5](#)).

 <b>WARNING</b>	
	<p><b>ELECTROCUTION HAZARD.</b></p> <p>All electrical work must be performed by a qualified electrician.</p> <p>Verify that all power to the machine has been turned off and follow approved lockout/tagout safety procedures before performing any maintenance.</p> <p>If it is absolutely necessary to troubleshoot an energized machine, follow NFPA 70E for proper procedures and personal protective equipment.</p> <p>When the disconnect switch is off, there is still live power within the disconnect switch's enclosure. Always turn off the power at the building's power source to the equipment before opening this electrical enclosure.</p>



1. Close machine software and shut down PC using the **Power > Shut down** method in Windows.
2. Engage an E-stop on the machine.
3. Turn the disconnect switch handle to the Off position. See [Figure 1](#).
4. Attach a lock and tag that meet OSHA requirements for lockout/tagout to the electrical service entry panel.

- Open the door to the enclosure to which you need access. Using a multimeter, verify that the power is off.

Figure 1: Disconnect Switch



### Pneumatic or Hydraulic System Lockout/Tagout Procedure

	 <b>WARNING</b>
	<p><b>HIGH PRESSURE HAZARD.</b></p> <p>Bleed pneumatic lines before performing any maintenance on the system.</p> <p>Working on pressurized lines may cause injury.</p>

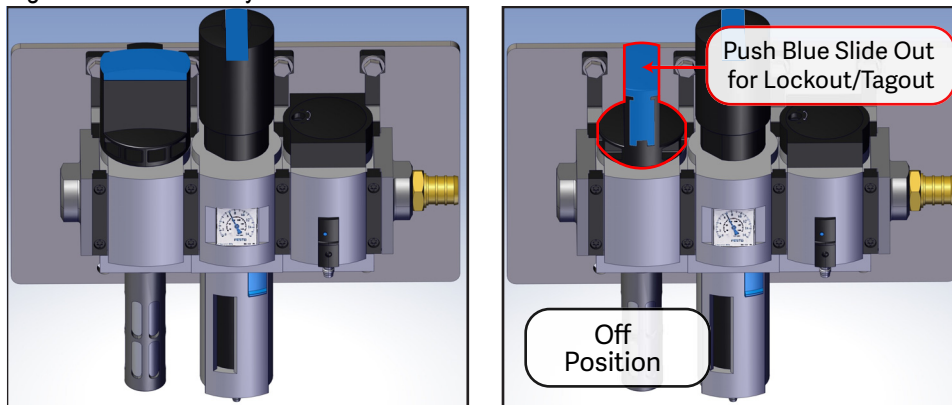

After lockout tagout of the electrical power, turn off or close the system's air shut-off valve and attach a lock and tag. See [Figure 2](#).

Figure 2: Pneumatic System Shut-Off Valve



## Procedure

### Updating the Electrical System

 <b>WARNING</b>	
	<p><b>MOVING PARTS CAN CRUSH AND CUT.</b></p> <p>Always verify that power to the machine has been turned off and follow approved lockout/tagout procedures.</p>



1. Install the Banner safety controller configuration software and download the config file (92277-503.xsc) to your laptop. Make note of the config file save location. See [Purpose and Scope on page 2](#) for links to files.
2. Lockout/tagout the electrical and pneumatic systems of the machine using the [Lockout/Tagout Instructions on page 3](#).
3. With power locked out as previously described, open the left door of the electrical enclosure.
4. The left side of the enclosure is composed of control components and is divided into 4 Control Rows as shown in [Figure 3](#). These rows will be referenced throughout these instructions to help locate specific components.

Figure 3: Control Rows (Left Enclosure Door)

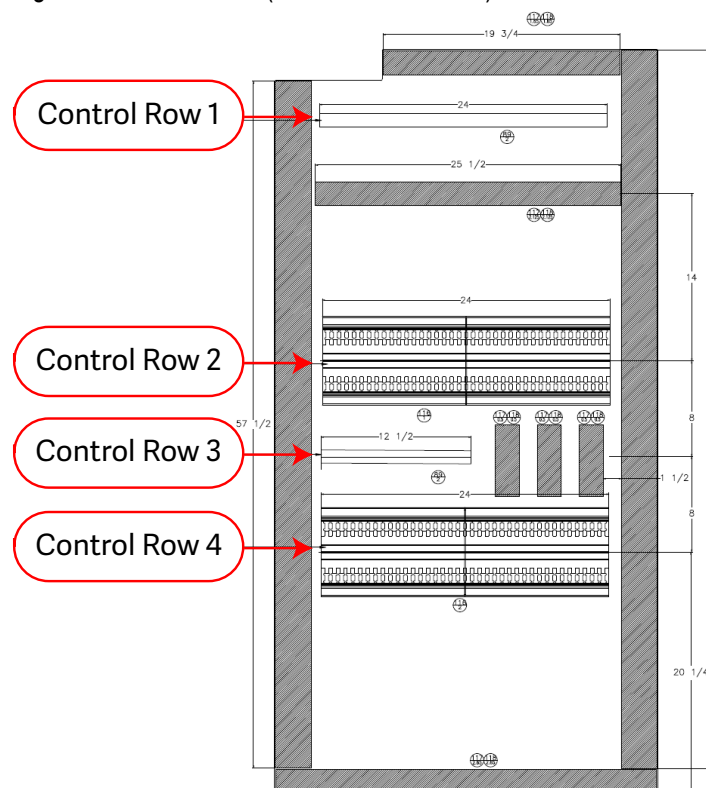

5. In Control Row 1, remove the DIN rail end stop and shift the EWON and Safety Controller to the left to allow room for the installation of the new terminal blocks and relays.
  - Shift the labels above the hardware as needed to match up with the new positioning.

Figure 4: Creating Space for New Components



<b>NOTICE</b>	
	<b>Use included wire labels to mark all wires with the correct names (ex: 52 or DL1).</b>

6. Reinstall the DIN rail end stop removed in step 5 on the left side of the EWON and Safety Controller.
7. Snap together the supplied 3 terminal blocks and the terminal block jumper. See [Figure 5](#) for an example of the completed assembly.



8. Matching the order shown in [Figure 5](#), install the terminal block jumper, the terminal block end, and the relays onto the DIN rail in the space created in the previous step.
  - Note that **M0-5** labels located above the safety controllers must be shifted left to match the new location of the hardware.

Figure 5: Installing Terminal Block Jumper and Relays

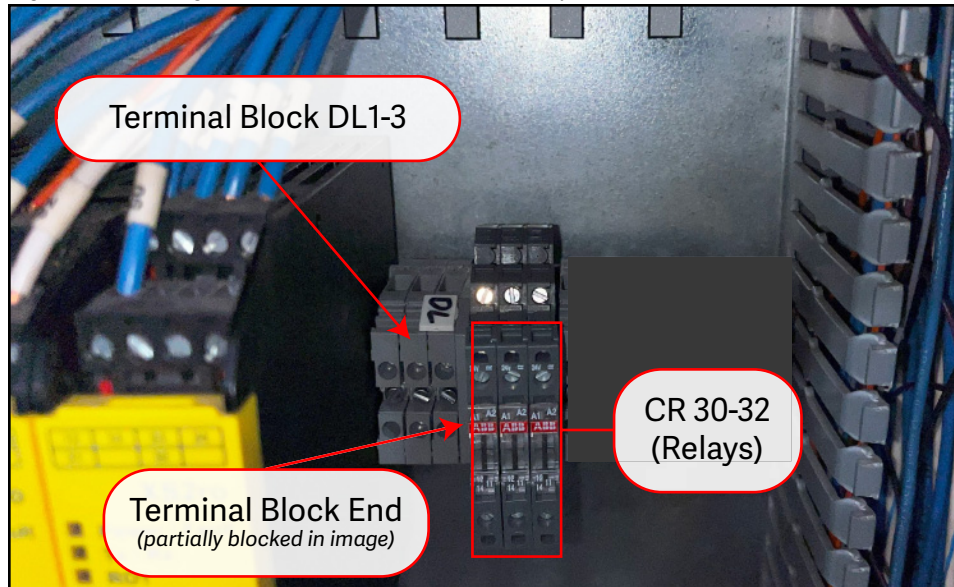

9. Use 2 white/blue wires (label 52) to jumper the A2 terminals on the relays together.

Figure 6: Jumper A2 on Relays

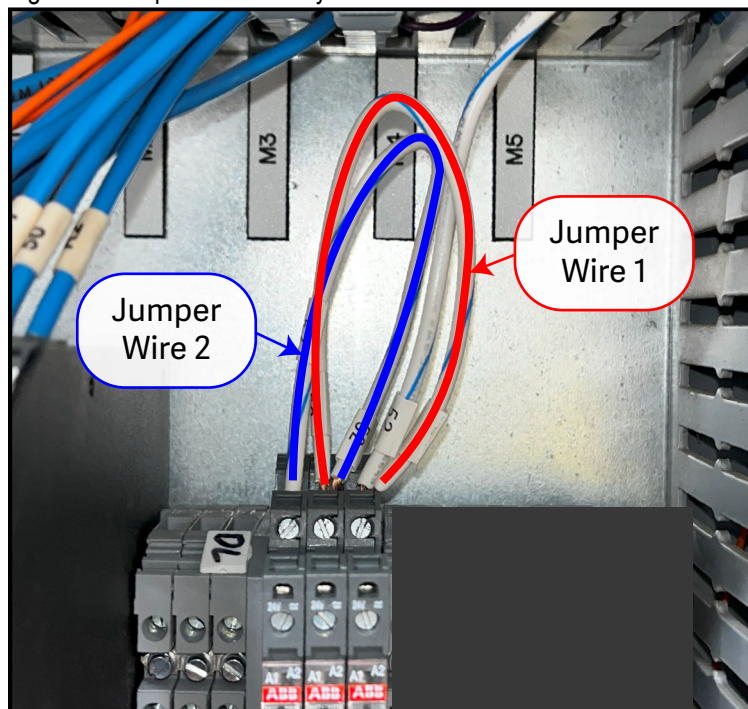

- Run a white/blue wire (label 52) from A2 of CR32 to TB 52-2 Top on Control Row 4.

Figure 7: TB 52-2 Top to A2

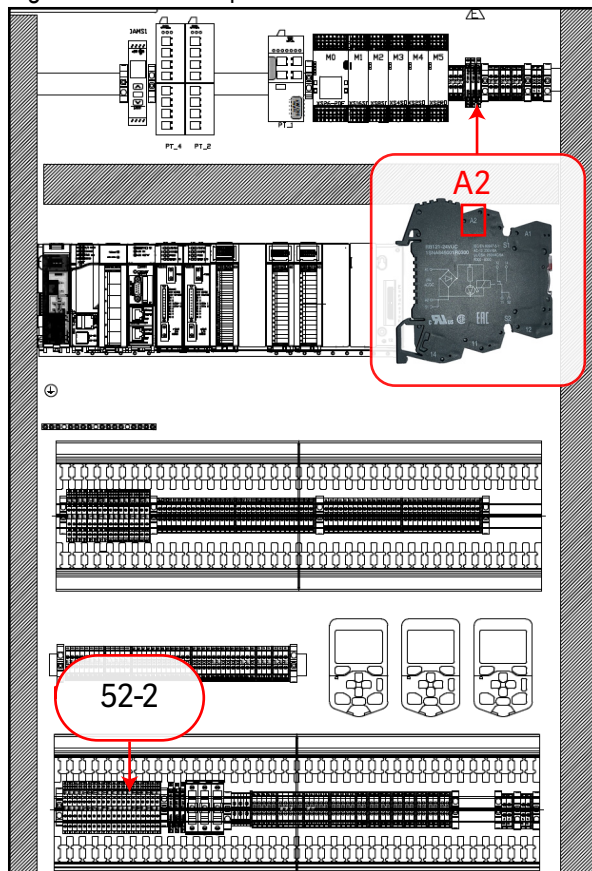

- Run blue wires from DL1, 2, and 3 Top (left to right) to A1 of the respective relays (left to right).

Figure 8: DL1-3 to A1 on Relays

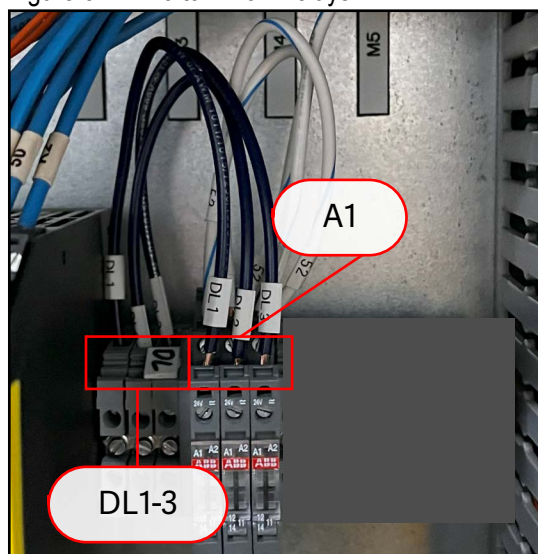



12. Run a blue wire (label S01b) from DL1 Bottom to M3-2 Top at the Safety Controller.

Figure 9: DL1 Bottom to M3-2 Top (Safety Controller)

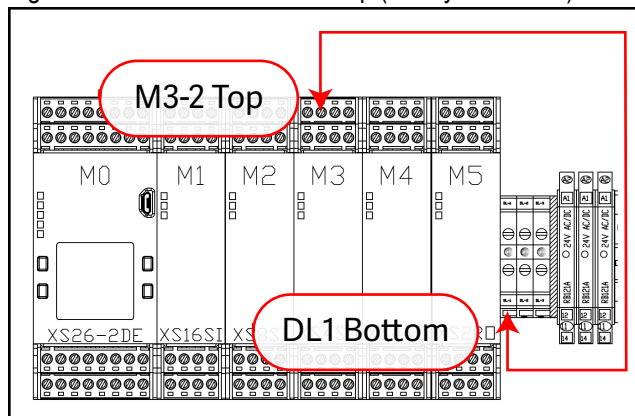

13. On Control Row 4, remove 3 wires from fuses 30-32 Bottom.
  - Because these wires are too short to reach the relays on Control Row 1, splicing connectors and additional blue wire will be used to cover the distance.

Figure 10: Fuses 30-32

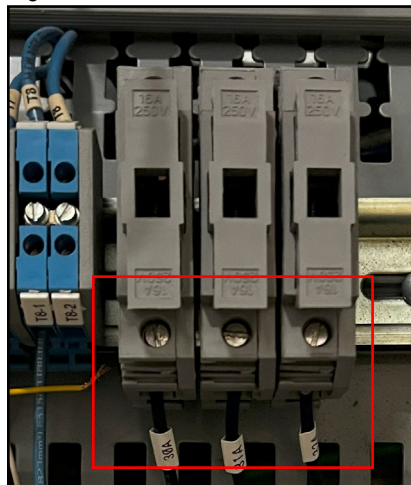

14. Cut 3 lengths of blue wire long enough to cover the distance between the disconnected fuse wires from the previous step and the relays in Control Row 1.
15. Pair each blue wire with a single wire (from fuses 30-32) using a splicing connector.

16. Connect the 3 spliced wires to CR30(12), CR31(12), and CR32(12) on the relays.

Figure 11: CR30(12) to 30-1 Bottom

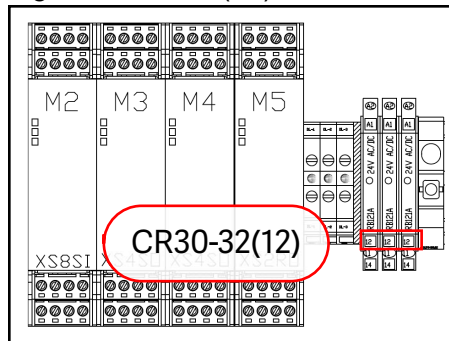

17. Cut 3 lengths of blue wire long enough to reach from the new relays to the fuses shown in Figure 11. Label them 30A, 31A, and 32A (matching the relays).
18. Connect the same 3 blue wires to CR30(11), CR31(11), and CR32(11) on the relays.

Figure 12: CR30(11) to Fuse 30 Bottom

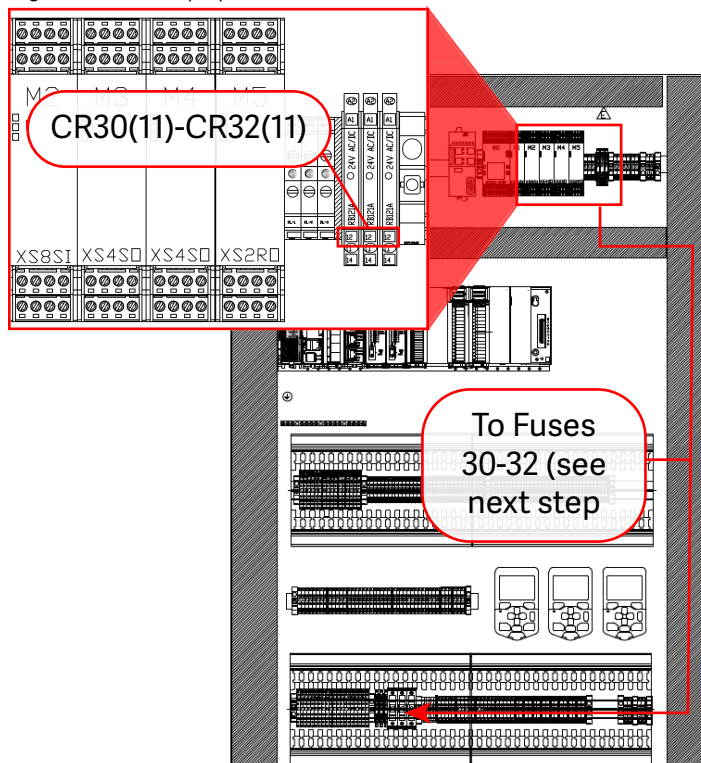

19. Connect the wires from the previous step to fuses 30-32 Bottom, matching their labels with the respective fuse numbers.
20. Now that all wiring is complete, install supplied the DIN rail end stop to right of the relays on Control Row 1 to secure all hardware on the rail.
21. Remove lockout/tagout devices and return power to the machine.

22. Connect your laptop to the safety controller unit with the LCD display using the USB type A to micro cable. See [Figure 16](#).
23. Launch the Banner configuration software by double left-clicking the config file 92277-503.xsc.
24. Select **Write Configuration to Controller** in the toolbar dropdown.

Figure 13: Write Configuration to Controller

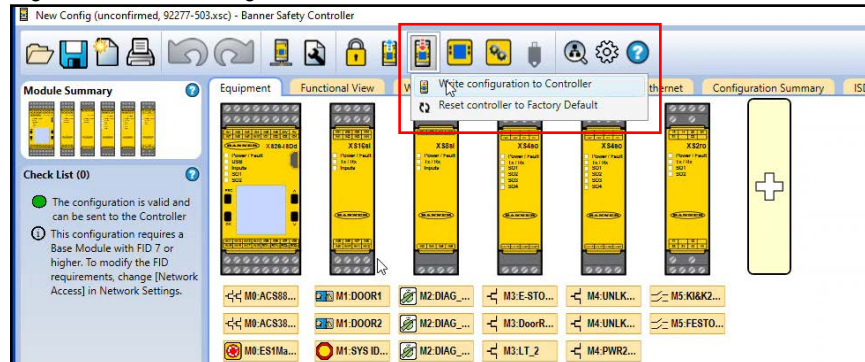

25. Select **Continue** when a window with the following text appears: **The [Network Access] options in the Network Settings will be disabled because the controller does not support this feature.**
26. Enter password in the password field and select **OK**.
  - Contact Automation Support for password if not already known. See master comments.

Figure 14: Password Field

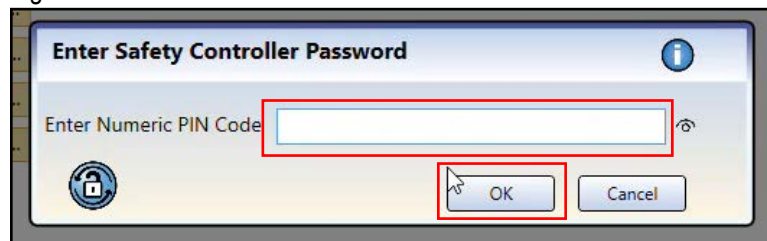

27. Select **Continue** when a window with the following text appears: **Continuing will force safety outputs to turn-off.**
  - A progress bar will appear.
28. When the **Confirm Configuration** window appears, scroll to the end of the results and select **Confirm**.

29. Once the progress bar completes and the following window appears, proceed to step 30.

Figure 15: Configuration Stored Confirmation

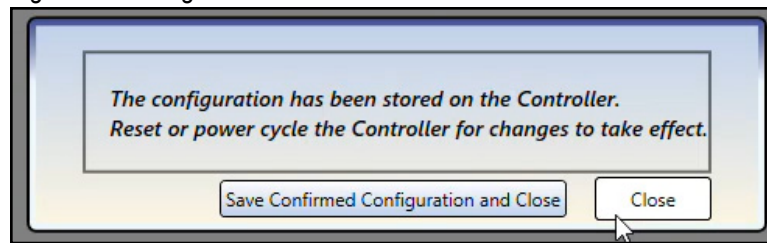

30. Once the configuration has been stored, the following message will appear on the safety controller display:

Figure 16: USB Port and Configuration Received Message

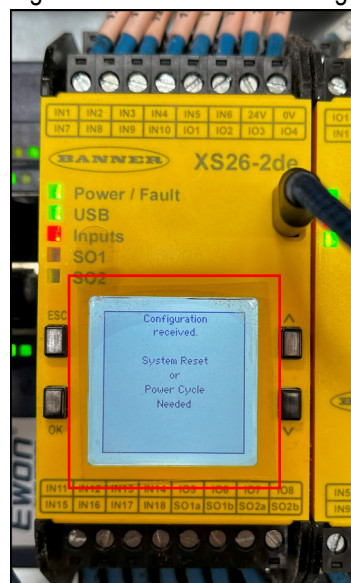

31. Power cycle the machine using the disconnect switch on the electrical enclosure.
32. After the power cycle is complete, select **Close** in the safety controller software. See [Figure 15](#).
33. Disconnect the laptop from the safety controller and close the left door of the electrical enclosure.
34. Release any active E-stops and press the **Reset** button on the operator interface to prepare the machine for operation.
35. Perform the interlock door test found in the safety chapter of the machine manual on all three interlock doors:
- saw chamber
  - stroke / evelation (infeed)
  - stroke / evelation (outfeed)

**END OF SERVICE BULLETIN**